

# KARGO MASTER®

WE PUT EVERYTHING WITHIN REACH.



KARGOMASTER.COM

40  
YEARS

2015 CATALOG

TRUCK RACKS &  
CARGO VAN EQUIPMENT



**WE PUT EVERYTHING WITHIN REACH.**

**For over 40 years ...**

**Kargo Master** has been giving you more. More function, more strength, more durability, and more style than any other manufacturer of truck and van equipment. When you purchase **Kargo Master**, you get the best products, the best warranty (lifetime), and the best price.

**Located in Rancho Cordova, California ...**

our 85,000 square foot manufacturing facility enables us to manufacture in house or source elsewhere to provide the industry's best value proposition. Design, fabrication,



powder coating, and packaging all take place under the watchful eye of company founder, Dave Lewis.

Innovation, automation, and critical process controls is what gives us the competitive edge, which in turn gives you a better deal.

**We manufacture and sell productivity ...**

Every **Kargo Master** product is thoughtfully designed to make you more efficient, more organized and more profitable. Faster, easier and safer, that is what we're all about. It's tough out there. You can't afford to waste any time accessing or storing your tools and supplies. Get there, get it done and get going with **Kargo Master** equipment.

**TRUCK RACKS & CARGO VAN EQUIPMENT**



**KARGO MASTER ALUMINUM INTERIORS**



**ANNOUNCING Kargo Master Featherweight Aluminum Interiors**

**for Mini Cargo Vans** (Available 2<sup>nd</sup> Quarter 2015)

Feather light shelf units are built with aluminum extrusions, embossed aluminum sides, and strong, impact resistant fiberglass reinforced (top and bottom) polypropylene honeycomb panel. Included rubber shelf mats keep your tools and supplies from sliding around. Available accessories include

shelf dividers, lockable door kits, and stackable plastic bins (10" W x 5.5" H x 11" D and 5" W x 3.5" H x 11" D). Two shelf widths are available. 32" W x 46" H x 12" D with installation brackets and fasteners weighs ONLY 30 lbs. 60" W x 46" H x 12" D with installation brackets and fasteners weighs ONLY 58 lbs.

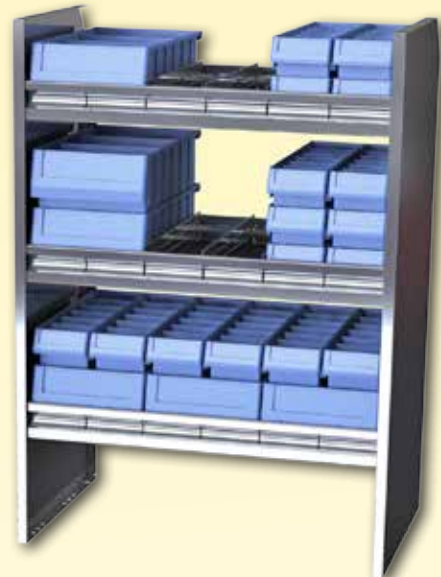

**ABOUT KARGO MASTER** Inside Front Cover

**KARGO MASTER VAN PARTS** 2

Partitions ..... 2  
 Window Screens ..... 3  
 Shelving Application Guide..... 4  
 EZ Adjustable Shelving ..... 5  
 Shelf Accessories ..... 6  
 Additional Van Equipment..... 8  
     Passenger Van Heavy-Duty No-Slip  
     Side Steps ..... 9  
     Heavy Duty 3 Drawer Unit ..... 10

**KARGO MASTER VAN PACKAGES** 11

**LOW ROOF FULL-SIZED VANS**

Van Packages Index & Introduction ..... 11  
     & Base (Shelves & Partition)  
 Commercial Bin ..... 12  
     & General Service  
 Tradesman ..... 13  
     & Heating & A/C Repair  
 Electric & Gas Appliance Repair..... 14  
     & Electrical Contractor  
 EZ General Service ..... 15  
     & EZ All Trades  
 General Contractor ..... 16  
     & America's Most Popular  
 Cable ..... 17  
     & Security

**MID/HIGH ROOF FULL-SIZED VANS**

Base (Shelves & Partitions) ..... 18  
     & General Service  
 Cable ..... 19  
     & Security  
 HVAC ..... 20  
     & Electrical Contractor  
 EZ All Trades ..... 21  
     & America's Most Popular

**KARGO MASTER VAN PACKAGES** (Continued)

**MINI CARGO VANS**

Commercial Shelving (Shelves &..... 22  
     Sheet Metal or Wire Partitions)  
 Deluxe Commercial Shelving ..... 23  
     & HVAC  
 General Service ..... 24  
     & Electrical Contractor  
 Plumbing ..... 25  
     & Telecom

**KARGO MASTER VAN RACKS** 26

About Kargo Master Van Cargo  
     & Ladder Racks ..... 26  
 Van Cargo & Ladder Racks  
     Application Guide ..... 27  
 EZ Lo-Down™ Ladder Racks ..... 28  
 Clamp & Lock Ladder Racks..... 29  
 Crossbar Cargo & Ladder Van Racks ..... 30  
     Cargo & Ladder Rack Accessories ..... 30  
 Utility Econo Van Cargo Racks ..... 31  
 Heavy-Duty Pro II Van Cargo Rack ..... 32  
 Covered Service Bodies Ladder Racks ..... 33

**KARGO MASTER TRUCK RACKS & EQUIPMENT** 34

About Kargo Master Truck Racks ..... 34  
 Truck Racks Application Guide ..... 35  
 Medium-Duty Pro IV Aluminum Pick Up  
     Truck Cargo Racks..... 36  
 Heavy-Duty Pro II Pick Up Truck  
     Cargo Rack ..... 37  
 Medium-Duty Pro III Pick Up Truck  
     Cargo Racks ..... 38  
 Medium-Duty Econo Pick Up Truck  
     Utility Racks ..... 39  
 Racks for Pick Up Trucks With Shells ..... 40  
 Additional Truck Racks ..... 41  
 Service Bodies Cargo & Ladder  
     Truck Racks ..... 42  
 Truck Rack Accessories ..... 43

**KARGO MASTER PRODUCT INDEX** 44

Cargo Van Product Index..... 44  
 Truck Product Index ..... Inside Back Cover  
 Cargo Buckle Tie Downs

# PARTITIONS

## SHEET METAL PARTITIONS



MINI CARGO VAN PARTITIONS



LOW ROOF FULL-SIZED VAN PARTITIONS



MID/HIGH ROOF FULL-SIZED VAN PARTITIONS

### Kargo Master Sheet Metal Partitions Features and Benefits

- 18 gauge steel, hemmed and embossed to provide extra strength, security and reduce noise.
- EXTRA SECURITY. Corner contoured to prevent reaching in from the cab to unlock side door.
- Optional tight compression center panel door latch handle and lock kit helps to prevent annoying rattle (see page 8).
- Quick and easy to install.
- Power coated with matte powder coat to minimize glare and resist scratching and chipping.
- Separate wing kits for GM, Ford, Sprinter and Ram ProMaster.
- Multiple partition attachment points and rubber cushioned door frame prevents noise.

VAN TYPE	PART #	DESCRIPTION
<b>Mini Cargo Van</b> *No Wing Kit Required		
Partition	40667	All Transit Connect/City Express/NV200 Sheet Metal Partition
Partition	406PC	Ram ProMaster City Partition
<b>Low Roof Full-Sized Van</b>		
Partition	40640	Common Low Roof Partition Panels *You must also select a wing kit for your vehicle from list below.
Wing Kit	4064C	GM Wing Kit
Wing Kit	4064F	Ford E-Series Wing Kit
Wing Kit	406TL	Ford Transit Low Roof Wing Kit
Wing Kit	406NL	Nissan NV Low Roof Wing Kit
<b>Mid/High Roof Full-Sized Van</b>		
Partition	40651	Common Mid/High Roof Partition Panels *You must also select a wing kit for your vehicle from list below.
Wing Kit	406TH	Ford Transit Mid/High Roof Wing Kit
Wing Kit	406NH	Nissan NV High Roof Wing Kit
Wing Kit	4064P	Ram ProMaster Low/High Roof Wing Kit
Wing Kit	406SL	Sprinter Low Roof Wing Kit
Partition	4061S	Sprinter High Roof Partition *Wing Kit Included
Center Panel Latch & Door Lock	40620	Kit for Low Roof and Mid/High Roof Full-Sized Vans (see page 8)



RAM PROMASTER VAN PARTITIONS



SPRINTER VAN PARTITIONS

## WIRE PARTITIONS

NEW



MINI CARGO VAN WIRE PARTITIONS

### Kargo Master Wire Partitions Features and Benefits

Heavy 7 gauge wire mesh (2.5" squares) keeps product, equipment, supplies and/or pets in the cargo area. An economical way to protect driver and passenger. Provides excellent rear visibility.

Designed so that cab seats can be fully pushed back and reclined somewhat for driver comfort. Quick easy installation uses existing factory mounts. Powder coated grey.

Van Type	Part #	Description
<b>Mini Cargo Van</b>		
Partition	40668	All Transit Connect/City Express/NV200 Wire Partition

(800) 343-7486

P2 VISIT [KARGOMASTER.COM](http://KARGOMASTER.COM) FOR MORE INFORMATION

**KARGO MASTER**

TRUCK RACKS & CARGO VAN EQUIPMENT

## For Ford E-Series, Transit, Transit Connect & GM



**FORD TRANSIT CONNECT HINGED REAR DOORS**

### Kargo Master **Window Screens** Features and Benefits

Our window screens add more security and protection to your valuable tools inside the van. Window screens are coated with a gray powder coat finish. Custom-fit window screens are easy to install; no assembly is required. All hardware is included.

- Industry's strongest 7 gauge wire frame and grid screens secure cargo area windows. A thief will need more than wire cutters to get through these.
- Powder coated no glare matte gray.
- Models available for GM and Ford E-Series sliding side and hinged doors, hinged rear doors for Ford Transit, Transit Connect, GM and Ford E-Series, and sliding side or hinged door for Ford Transit.
- Nationwide lifetime frame Warranty.

PART #	COLOR	DESCRIPTION
4070F	Grey	Ford E-Series Side Door Hinged (set of 2)
4071F	Grey	Ford E-Series Side Door Sliding (single)
4072F	Grey	Ford E-Series Rear Door Hinged (set of 2)
4070C	Grey	GM Side Door Hinged (set of 2)
4070T	Grey	2015+ Low Roof Ford Transit Side Door Hinged (set of 2)
4071C	Grey	GM Side Door Sliding (set of 2)
4071T	Grey	2015+ Low Roof Ford Transit Side Door Sliding (set of 2)
4072C	Grey	GM Rear Door Hinged (set of 2)
4073T	Grey	2015+ Low Roof Ford Transit Rear Door Hinged (set of 2)
4075T	Grey	2015+ Mid/High Roof Ford Transit Side Door Sliding (set of 2)
4076T	Grey	2015+ Mid/High Roof Ford Transit Rear Door Hinged (set of 2)
4079T	Grey	2014+ Ford Transit Connect Rear Door Hinged



**GM & FORD HINGED SIDE DOORS**



**GM SIDE DOOR SLIDING**



**FORD TRANSIT HINGED REAR DOORS**



# SHELVING Application Guide

	Adjustable Shelf Unit 26" W x 46" H	Adjustable Shelf Unit 32" W x 46" H	Adjustable Shelf Unit 42" W x 46" H	<b>TALL</b> Adjustable Shelf Unit 42" W x 60" H	Adjustable Shelf Unit 52" W x 46" H	<b>TALL</b> Adjustable Shelf Unit 52" W x 60" H
VAN TYPES	PART #	PART #	PART #	PART #	PART #	PART #
<b>LOW ROOF FULL-SIZED VANS</b>						
Ford E-Series	4826T	48320	48420	N/A	48520	N/A
Ford Transit	4826T	48320	48420	N/A	48520	N/A
GM	4826T	48320	48420	N/A	48520	N/A
Nissan NV	4826T	48320	48420	N/A	48520	N/A

<b>MID/HIGH ROOF FULL-SIZED VANS</b>						
Ford Transit	N/A	N/A	48420	48424	N/A	48524
Nissan NV	N/A	N/A	48420	48424	N/A	48524
Ram ProMaster	N/A	N/A	48420	48424	N/A	48524
Sprinter	N/A	N/A	48420	48424	N/A	48524

<b>MINI CARGO VANS</b>						
Chevy City Express	4826T	4832M	N/A	N/A	N/A	N/A
Ford Transit Connect	4826T	4832M	48420	N/A	N/A	N/A
Nissan NV200	4826T	4832M	N/A	N/A	N/A	N/A
Ram ProMaster City	4826T	4832M	N/A	N/A	N/A	N/A

## KARGO MASTER OFFERS SHELF SIZES TO FIT EVERY VAN



**46" Units Have 3 Shelves**

**4826T** 26" W x 46" H  
**48320** 32" W x 46" H  
**4832M** 32" W x 46" H  
**48420** 42" W x 46" H  
**48520** 52" W x 46" H

**60" Units Have 4 Shelves**

**48424** 42" W x 60" H  
**48524** 52" W x 60" H



## Popular Kargo Master Shelf Accessories

(See Pages 6 & 7 for All Choices)



(800) 343-7486

P4 VISIT [KARGOMASTER.COM](http://KARGOMASTER.COM) FOR MORE INFORMATION

**KARGO MASTER**

TRUCK RACKS & CARGO VAN EQUIPMENT

Available in 7 Sizes for all Cargo Vans - Quick, Easy & Economical

## Kargo Master EZ Adjustable Shelving Features and Benefits

The **Kargo Master EZ Adjustable Shelving System** is one of the most durable and flexible shelving systems available on the market. All **Kargo Master** shelving units are built with a unique lance support technique, which provides additional shelf-to-structure support on each shelf layer. Each van shelf is constructed with powder coated heavy duty steel that provides protection against abrasive use. The individual shelves of each **Kargo Master** shelving unit can be adjusted to differing heights depending on each unique shelving need. Van shelves are also contoured with the frame to enable the unit to fit flush against your van walls; maximizing space. Steel backings are included with these shelves. Each shelf comes with built-in 2" lips to retain cargo during transport. Additional **Kargo Master** shelving accessories are available to customize your van storage needs!



- Convenient formed shelf supports and permanent "pressed-in" fasteners enable you to assemble EZ shelf units in only 15 minutes. Contoured end panels provide flush fit to van side, widest possible van aisle.
- Contoured full steel shelf back provides additional strength and convenience.
- Position the middle shelf to accept **Kargo Master** standard drawer cabinets, or select two other practical shelf heights. Or, install an accessory 4th shelf. Middle shelf height can be adjusted with shelf unit mounted in the van.
- Each shelf comes with built-in 2" lips to contain cargo.
- EZ shelving is specifically designed to reduce noise and rattle.

PART #	DESCRIPTION
4826T	Adjustable Shelf Unit 26"W x 46"H x 14" D
48320	Adjustable Shelf Unit 32"W x 46"H x 14" D
4832M	Adjustable No Drill Shelf Unit 32"W x 46"H x 14" D For 2014 Transit Connect, NV200, Chevy City Express, Ram ProMaster
48420	Adjustable Shelf Unit 42"W x 46"H x 14" D
48424	Adjustable Tall Shelf Unit 42"W x 60"H x 14" D
48524	Adjustable Tall Shelf Unit 52"W x 60"H x 14" D
48520	Adjustable Shelf Unit 52"W x 46"H x 14" D



**EZ ADJUSTABLE SHELVING IS SPECIFICALLY DESIGNED TO REDUCE NOISE AND RATTLE**

OPEN DOOR VIEW  
OF KARGO MASTER  
EZ ADJUSTABLE  
SHELVING INSTALLED  
IN A FORD TRANSIT  
CONNECT MINI  
CARGO VAN.



## Lots of Convenient Accessories to Extend Your Van's Usefulness



### Door Shelf Kits

- Adds protection for your valuable tools.
- Rubber silencer eliminates rattling and noise.

40010	For 42" W Shelf
40020	For 32" W Shelf
40040	For 52" W Shelf

### Floor Angle/Shelf Lips

48220	42" W x 3.5" H Floor Angle/Shelf Lip to Mount 42" Door Kit 40010 in Floor Opening
48230	52" W x 3.5" H Floor Angle/Shelf Lip to Mount 52" Door Kit 40040 in Floor Opening



### Steel 2 Drawer Cabinet

- 20" W x 12" H x 13.5" D
- Heavy-duty 40# ball bearing slides.
- Individual drawer latches.

40070	Steel 2 Drawer Cabinet
-------	------------------------

### 20" Shelf Lip



48180	20" L x 2.75" H Shelf Lip for 48420
-------	-------------------------------------



### Steel 3 Drawer Cabinet

- 20" W x 12" H x 13.5" D
- Heavy-duty 40# ball bearing slides.
- Individual drawer latches.
- Plastic small parts divider for shallow drawer.

40080	Steel 3 Drawer Cabinet
-------	------------------------

### 10" Shelf Lip



48190	10" L x 2.75" H Shelf Lip for 48320 and 4832T
-------	---



### Steel 4 Drawer Cabinet

- 20" W x 12" H x 13.5" D
- Heavy-duty 40# ball bearing slides.
- Individual drawer latches.
- Plastic small parts divider for shallow drawer.

40090	Steel 4 Drawer Cabinet
-------	------------------------

### 3-Prong "J" Hook



40060	3 Prong "J" Hook
-------	------------------



### Extra Shelves

- Customize your work van with additional shelving.
- Easy to install. No assembly required.

48150	52" W Extra Shelf for 48520 & 48524
48160	42" W Extra Shelf for 48420 & 48424
48170	32" W Extra Shelf for 48320

## More Convenient Accessories to Help You Organize Your Van

### Shelf Dividers 3.5" Tall

Upper & Lower Shelf (set of 6)



40030 Shelf Dividers 3.5" Tall

### 10" W Plastic Bin Module

2 x 10" W x 5.5" H x 11" D Bins  
+ 4 dividers (includes shelf lip)



**NEW**

48210 10" W Plastic Bin Module

### Plastic Drawer Bin with Dividers

add to 40250 11" W x 4" H x 8" D



40140 Plastic Drawer Bin with Dividers

### 20" W Plastic Bin Module

4 x 10" W x 5.5" H x 11" D Bins  
+ 8 dividers (includes shelf lip)



**NEW**

48200 20" W Plastic Bin Module

### 10" W Plastic Shelf Bin

10" W x 5.5" H x 11" D Bins + 2 dividers



**NEW**

40310 10" W Plastic Shelf Bin

### 20" W Plastic Small Parts Bin Module

12 x 5" W x 3.5" H x 11" D Bins  
+ 60 dividers (includes shelf lip)

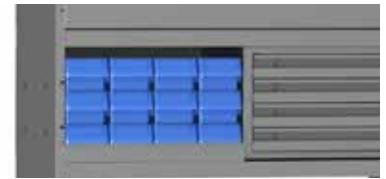

48240 20" W Plastic Small Parts Bin

### 10" W Plastic Small Parts Bin Module

includes 6 x 5" W x 3.5" H x 11" D Bins  
+ 30 dividers (includes shelf lip)

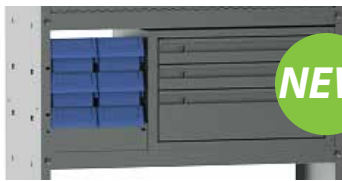

**NEW**

48250 10" W Plastic Small Parts Bin

### 5" W Plastic Small Parts Bin

5" W x 3.5" H x 11" D Bins + 5 dividers



**NEW**

40330 5" W Plastic Small Parts Bin



# ADDITIONAL VAN EQUIPMENT

## Other Items to Configure Your Van Just the Way You Want It

### 3 Tier Refrigerant Tank Rack

- Securely holds 3-30 lb. tanks or 1-50 lb. and 2-30 lb. tanks or any combination thereof.
- 14 gauge steel frame with sloped cradles and nylon retention straps.
- Fully welded.
- No assembly required.



40200 3 Tier Refrigerant Tank Rack

### 4-Tier Refrigerant Tank Rack

- Securely holds 4-9.5" diameter 30# tanks to maximize space.
- .25" steel bar frame with sloped cradles and nylon retention straps.
- Fully welded.
- No assembly required.



40100 4 Tier Refrigerant Tank Rack

### Driver Data File

- Heavy-duty 12"W x 18"H x 20" D cabinet.
- Hinged lockable top with clip to hold papers.
- Built-in rails for hanging folders.



40210 Driver Data File

### Standing Bin Holder

7 x 10" W Bins with 2 dividers each



40290 Standing Bin Holder w/Bins

### Wire Reel Holder 5 Spindle



- 14.25" W x 29" H x 7.75" D
- 5 x rotation roll bar included.
- Adjustable spacing.
- Fits up to 3 x 12" diameter cable spool or 5 x smaller cable spool.
- Optimizes space.

40230 Wire Reel Holder 5 Spindle

### Standing Binder Rack



- 10" W x 46" H x 12" D
- Three interior shelving slots for easy storage of thick manuals.
- Open top desk region provides perfect work space.
- Great for access to reference materials.

40280 Standing Binder Rack

NEW

### Cabinet Locker Full Door



- Heavy-duty 18" W x 46" H x 14" D cabinet.
- 2 removable shelves.
- Heavy-duty "T" handle locking latch.
- No assembly required. Quick and easy install.
- Contoured top lets cabinet install flush against van walls.

40220 Cabinet Locker Full Door

### Hanging File Rack



- Easy filing for clipboards, work schedules, manuals and other documents.

40270 Hanging File Rack

NEW

### Wire Water Jug Holder



40300 Wire Water Jug Holder

NEW

### Center Panel Latch & Door Lock Kit (for Partitions)



- Provides easy access from driver side to cargo area.

40620 Center Panel Latch & Door Lock

(800) 343-7486

P8 VISIT [KARGOMASTER.COM](http://KARGOMASTER.COM) FOR MORE INFORMATION

**KARGO MASTER**

TRUCK RACKS & CARGO VAN EQUIPMENT

## PASSENGER VAN HEAVY-DUTY NO-SLIP SIDE STEPS



- Heavy-duty 10" wide 14 gauge steel steps and rigid thick mount brackets support passengers of all sizes.
- Steps have raised perforations for superior traction. Rain and snow drain through.
- Steps are made with galvanized steel and coated with zinc epoxy prime for superior corrosion protection.
- Finish powder coat is handsome metallic silver.
- Side steps have "reflective marking tape" for extra safety.

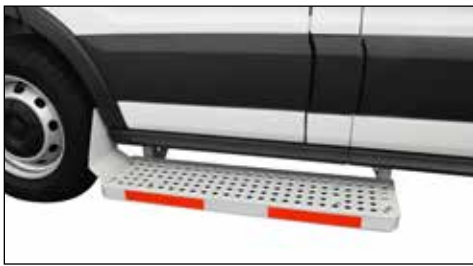

**ABOVE: PASSENGER SIDE**

**LEFT: DRIVER SIDE**

4700F	E-Series Ford Cab Steps, Driver and Passenger Side (2 x 40" Steps with Mount Kit)
4701F	E-Series Ford Passenger Area Step (1 x 60" Step with Mount Kit)
4700T	Ford Transit Cab Steps, Driver and Passenger Side (2 x 40" Steps with Mount Kit)
4701T	Ford Transit Passenger Area Step (1 x 40" Step with Mount Kit)
4702T	Ford Transit Long Wheel Base Passenger Area Step (1 x 60" Step with Mount Kit)
4700C	GM Cab Steps, Driver and Passenger Side (2 x 40" Steps with Mount Kit)
4701C	GM Passenger Area Step (1 x 60" Step with Mount Kit)

### KARGO MASTER IS ALWAYS OPEN FOR BUSINESS

- DOWNLOAD AN ELECTRONIC CATALOG
- VIEW INSTALLATION GUIDES AND TECHNICAL SPECS
- REQUEST A QUOTE
- CONTACT CUSTOMER SERVICE
- VIEW OR RECEIVE NEW PRODUCT ANNOUNCEMENTS
- SIGN-UP TO RECEIVE EMAIL NOTIFICATIONS OF NEW PRODUCTS



[kargomaster.com](http://kargomaster.com)

# HEAVY-DUTY LONG 3 DRAWER UNIT

## FLOOR 3 DRAWER UNIT



### Product Features and Benefits

- Heavy-duty long (56") 3 drawer cabinet can be installed on the floor behind the bulkhead (side door pull out) or above the rear wheel well (using accessory rotating wheel well stand).
- 52" drawer extension provides ready access to equipment and parts while standing outside the van.
- Each heavy-duty drawer has a 175# load capacity.
- Unit includes 1 - 11" deep drawer and 2 - 5" deep drawers.
- Includes 4 plastic bins & bin dividers.
- Mounts hard against the passenger or driver side of the van, keeping the aisle clear for storage or passage.

40250

Long Heavy-Duty Steel  
3 Drawer Unit

## ROTATING WHEEL WELL STAND for Floor Drawer Unit

### Product Features and Benefits

- Designed to support fully loaded Heavy-Duty 3 Drawer Floor Unit.
- Allows Drawer Cabinet to be rotated slightly so drawer will clear the van rear door jam.
- Heavy-duty ball and roller bearings ensure smooth stable rotation.
- Stand has positive stops to lock cabinets in rotated and non-rotated position.



40260

Rotating Wheel Well Stand  
(Use with 40250 Above)

(800) 343-7486

P10 VISIT [KARGOMASTER.COM](http://KARGOMASTER.COM) FOR MORE INFORMATION

**KARGO MASTER**

TRUCK RACKS & CARGO VAN EQUIPMENT

## FIND A PACKAGE

	LOW	M/H	MINI
	Page #		
Base (Shelves & Partition)	11	18	22
America's Most Popular	16	21	--
Cable	17	19	--
Commercial Bin	12	--	20
Deluxe Commercial	--	--	23
Electric & Gas			
Appliance Repair	14	--	--
Electrical Contractor	14	20	24
EZ All Trades	15	21	--
EZ General Service	15	--	--
General Contractor	16	--	--
General Service	12	18	24
Heating & A/C Repair	13	--	--
HVAC	--	20	23
Plumbing	--	--	25
Security	17	19	--
Telecom	--	--	25
Tradesman	13	--	--

KEYS: LOW = **FULL-SIZED LOW ROOF**  
M/H = **FULL-SIZED MID/HIGH ROOF**  
MINI = **MINI CARGO VAN**

## KARGO MASTER PACKAGES MAKE IT EASY TO CHOOSE.

Our professional designers and product engineers have created customized van packages for specific service categories to help you easily outfit a van based on input from experienced industry tradesmen. These packages make one more efficient, more productive, more profitable and save wear and tear on your back and knees.

The chart on the left will help you locate available packages in the catalog by vehicle type. Naturally, since all **Kargo Master** products are modular, one can easily mix and match parts to one's liking either by building a custom configuration, or by adding parts to one of the available packages.

To view pre-configured packages, first choose your van type by roof height: **LOW ROOF (PAGES 11-17)**, **MID/HIGH ROOF (PAGES 18-21)** or **MINI CARGO VANS (PAGES 22-25)**. Then thumb through the offerings until you find a package that meets your requirements.

Please note, all standard shelving for **LOW ROOF** and **MINI CARGO VANS** is 46" high ... for **MID/HIGH ROOF** vans the shelving is 60" high.

For more information, or assistance with product information, contact a **Kargo Master** dealer, distributor or upfitter, call us at **(800) 343-7486**, or search on our website: [kargomaster.com](http://kargomaster.com).

## BASE PACKAGES 46" H Shelves

PACKAGE	PKG. PART #	PARTITION PART #
GM STANDARD WHEEL BASE	4001C	40640 + 4064C
GM LONG WHEEL BASE	4013C	40640 + 4064C
FORD TRANSIT STANDARD WHEEL BASE LOW ROOF	40TRL	40640 + 406TL
FORD TRANSIT LONG WHEEL BASE LOW ROOF	40TLL	40640 + 406TL
NISSAN NV STANDARD WHEEL BASE LOW ROOF	40NVL	40640 + 406NL

**IMPORTANT.** THESE PARTITION PARTS ARE INCLUDED IN EACH PACKAGE, AND ARE REQUIRED TO BUILD A PACKAGE.

### STANDARD WHEEL BASE PACKAGES INCLUDE

Item Qty. Part #	Description	Item Qty. Part #	Description
1 (1)	Partition & Wing Kit (see above)	2 (3)	48420 42"W Adjustable Shelf

### LONG WHEEL BASE PACKAGES INCLUDE

Item Qty. Part #	Description	Item Qty. Part #	Description
1 (1)	Partition & Wing Kit (see above)	2 (3)	48520 52"W Adjustable Shelf

Optional **Center Panel Lock & Door Lock Kit**, Part #40620 (see page 8)



GM EXPRESS STANDARD WHEEL BASE PART #4001C ILLUSTRATED

# LOW ROOF Full-Sized Van Packages

## COMMERCIAL BIN PACKAGES 46" H Shelves

PACKAGE	PKG. PART #	PARTITION PART #
GM STANDARD WHEEL BASE	4003C	40640 + 4064C
FORD TRANSIT STANDARD WHEEL BASE LOW ROOF	43TRL	40640 + 406TL

**IMPORTANT.** THESE PARTITION PARTS ARE INCLUDED IN EACH PACKAGE, AND ARE REQUIRED TO BUILD A PACKAGE.

### STANDARD WHEEL BASE PACKAGES INCLUDE

Item	Qty.	Part#	Description	Item	Qty.	Part#	Description
1	(1)		Partition & Wing Kit (see above)	4	(1)	40030	Shelf Dividers (Set of 6)
2	(3)	48420	42"W Adjustable Shelf	5	(1)	48180	20" Shelf Lip
3	(1)	40080	Steel 3 Drawer Cabinet				

Optional **Center Panel Lock & Door Lock Kit**, Part #40620 (see page 8)



GM EXPRESS STANDARD WHEEL BASE PART #4003C ILLUSTRATED

## GENERAL SERVICE PACKAGES 46" H Shelves

PACKAGE	PKG. PART #	PARTITION PART #
GM STANDARD WHEEL BASE	4004C	40640 + 4064C
FORD TRANSIT STANDARD WHEEL BASE LOW ROOF	44TRL	40640 + 406TL
FORD TRANSIT LONG WHEEL BASE LOW ROOF	41TLL	40640 + 406TL
NISSAN NV STANDARD WHEEL BASE LOW ROOF	44NVL	40640 + 406NL

**IMPORTANT.** THESE PARTITION PARTS ARE INCLUDED IN EACH PACKAGE, AND ARE REQUIRED TO BUILD A PACKAGE.

### STANDARD WHEEL BASE PACKAGES INCLUDE

Item	Qty.	Part #	Description	Item	Qty.	Part #	Description
1	(1)		Partition & Wing Kit (see above)	5	(2)	40010	42"W Shelf Door Kit
2	(3)	48420	42"W Adjustable Shelf	6	(1)	40030	Shelf Dividers (Set of 6)
3	(1)	40070	Steel 2 Drawer Cabinet	7	(2)	40060	3-Prong "J" Hook
4	(1)	40080	Steel 3 Drawer Cabinet				

### LONG WHEEL BASE PACKAGES INCLUDE

Item	Qty.	Part #	Description	Item	Qty.	Part #	Description
1	(1)		Partition & Wing Kit (see above)	5	(2)	40040	52"W Shelf Door Kit
2	(3)	48520	52"W Adjustable Shelf	6	(1)	40030	Shelf Dividers (Set of 6)
3	(1)	40070	Steel 2 Drawer Cabinet	7	(2)	40060	3-Prong "J" Hook
4	(1)	40080	Steel 3 Drawer Cabinet				
				(1)		48190	10"W Shelf Lip (not shown)

Optional **Center Panel Lock & Door Lock Kit**, Part #40620 (see page 8)



GM EXPRESS STANDARD WHEEL BASE PART #4004C ILLUSTRATED

(800) 343-7486

**KARGO MASTER**

TRUCK RACKS & CARGO VAN EQUIPMENT

## TRADESMAN PACKAGES 46" H Shelves

PACKAGE	PKG. PART #	PARTITION PART #
GM STANDARD WHEEL BASE	4010C	40640 + 4064C
FORD TRANSIT STANDARD WHEEL BASE LOW ROOF	41TRL	40640 + 406TL

**IMPORTANT.** THESE PARTITION PARTS ARE INCLUDED IN EACH PACKAGE, AND ARE REQUIRED TO BUILD A PACKAGE.

### STANDARD WHEEL BASE PACKAGES INCLUDE ◀

Item	Qty.	Part#	Description	Item	Qty.	Part#	Description
1	(1)		Partition & Wing Kit (see above)	4	(1)	48200	Plastic Shelf Bin Module
2	(3)	48420	42"W Adjustable Shelf	5	(1)	40010	42"W Shelf Door Kit
3	(1)	40070	Steel 2 Drawer Cabinet				

Optional **Center Panel Lock & Door Lock Kit**, Part #40620 (see page 8)



GM EXPRESS STANDARD WHEEL BASE PART #4010C ILLUSTRATED

## HEATING & A/C REPAIR PACKAGES 46" H Shelves

PACKAGE	PKG. PART #	PARTITION PART #
GM STANDARD WHEEL BASE	4006C	40640 + 4064C
FORD TRANSIT STANDARD WHEEL BASE LOW ROOF	46TRL	40640 + 406TL
FORD TRANSIT LONG WHEEL BASE LOW ROOF	45TLL	40640 + 406TL
NISSAN NV STANDARD WHEEL BASE LOW ROOF	46NVL	40640 + 406NL

**IMPORTANT.** THESE PARTITION PARTS ARE INCLUDED IN EACH PACKAGE, AND ARE REQUIRED TO BUILD A PACKAGE.

### STANDARD WHEEL BASE PACKAGES INCLUDE ◀

Item	Qty.	Part #	Description	Item	Qty.	Part #	Description
1	(1)		Partition & Wing Kit (see above)	5	(2)	40080	Steel 3 Drawer Cabinet
2	(3)	48420	42"W Adjustable Shelf	6	(1)	40200	Refrigerant Tank Rack
3	(2)	40010	42"W Shelf Door Kit	7	(1)	40030	Shelf Dividers (Set of 6)
4	(2)	40070	Steel 2 Drawer Cabinet	8	(1)	40060	3-Prong "J" Hook

### LONG WHEEL BASE PACKAGES INCLUDE ◀

Item	Qty.	Part #	Description	Item	Qty.	Part #	Description
1	(1)		Partition & Wing Kit (see above)	6	(1)	40200	Refrigerant Tank Rack
2	(3)	48520	52"W Adjustable Shelf	7	(1)	40030	Shelf Dividers (Set of 6)
3	(2)	40040	52"W Shelf Door Kit	8	(1)	40060	3-Prong "J" Hook
4	(2)	40070	Steel 2 Drawer Cabinet		(2)	48190	10"W Shelf Lip (not shown)
5	(2)	40080	Steel 3 Drawer Cabinet				

Optional **Center Panel Lock & Door Lock Kit**, Part #40620 (see page 8)



GM EXPRESS STANDARD WHEEL BASE PART #4006C ILLUSTRATED

# LOW ROOF Full-Sized Van Packages

## ELECTRIC GAS & APPLIANCE REPAIR PACKAGES 46" H Shelves

PACKAGE	PKG. PART #	PARTITION PART #
GM STANDARD WHEEL BASE	4005C	40640 + 4064C
FORD TRANSIT STANDARD WHEEL BASE LOW ROOF	45TRL	40640 + 406TL

**IMPORTANT.** THESE PARTITION PARTS ARE INCLUDED IN EACH PACKAGE, AND ARE REQUIRED TO BUILD A PACKAGE.

### STANDARD WHEEL BASE PACKAGES INCLUDE

Item	Qty.	Part#	Description	Item	Qty.	Part#	Description
1	(1)		Partition & Wing Kit (see above)	6	(1)	40090	Steel 4 Drawer Cabinet
2	(3)	48420	42" W Adjustable Shelf	7	(1)	40230	Wire Reel Holder 5 Spindle
3	(2)	40010	42" W Shelf Door Kit	8	(1)	40060	3-Prong "J" Hook
4	(1)	40070	Steel 2 Drawer Cabinet	9	(1)	40030	Shelf Dividers (Set of 6)
5	(2)	40080	Steel 3 Drawer Cabinet				

Optional **Center Panel Lock & Door Lock Kit**, Part #40620 (see page 8)

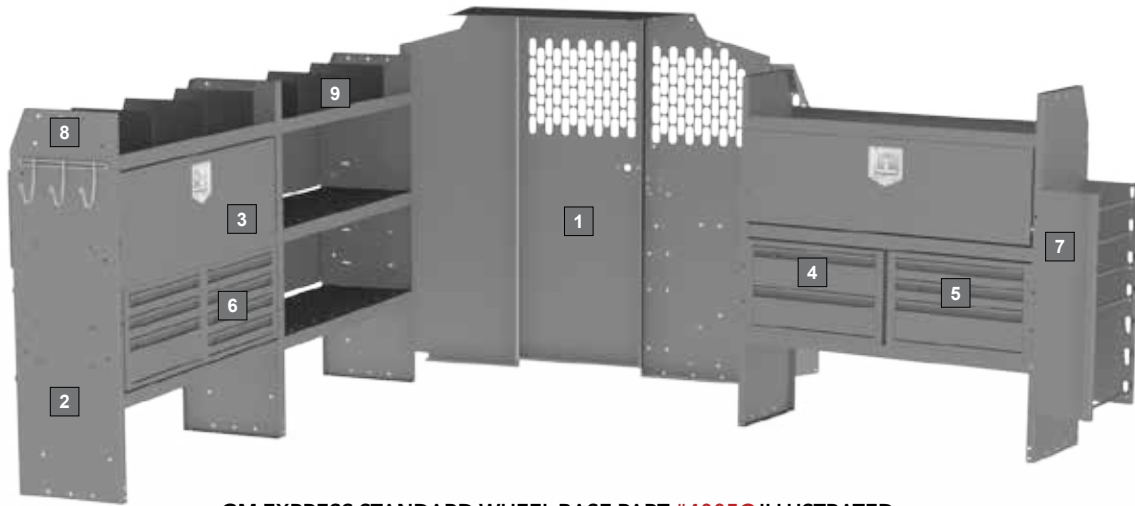

GM EXPRESS STANDARD WHEEL BASE PART #4005C ILLUSTRATED

## ELECTRICAL CONTRACTOR PACKAGES 46" H Shelves

PACKAGE	PKG. PART #	PARTITION PART #
FORD TRANSIT LONG WHEEL BASE LOW ROOF	42TLL	40640 + 406TL

**IMPORTANT.** THESE PARTITION PARTS ARE INCLUDED IN EACH PACKAGE, AND ARE REQUIRED TO BUILD A PACKAGE.

### LONG WHEEL BASE PACKAGES INCLUDE

Item	Qty.	Part#	Description	Item	Qty.	Part#	Description
1	(1)		Partition & Wing Kit (see above)	7	(1)	48240	Plastic Bin Shelf Module
2	(3)	48520	52" W Adjustable Shelf	8	(1)	40230	Wire Reel Holder 5 Spindle
3	(2)	40040	52" W Shelf Door Kit	9	(1)	40060	3-Prong "J" Hook
4	(1)	40070	Steel 2 Drawer Cabinet	10	(1)	40030	Shelf Dividers (Set of 6)
5	(1)	40080	Steel 3 Drawer Cabinet	11	(2)	48190	10" W Shelf Lip
6	(1)	40090	Steel 4 Drawer Cabinet				

Optional **Center Panel Lock & Door Lock Kit**, Part #40620 (see page 8)



FORD TRANSIT LONG WHEEL BASE PART #42TLL ILLUSTRATED

(800) 343-7486

**KARGO MASTER**

P14 VISIT [KARGOMASTER.COM](http://KARGOMASTER.COM) FOR MORE INFORMATION

TRUCK RACKS & CARGO VAN EQUIPMENT

## EZ GENERAL SERVICE PACKAGES 46" H Shelves

PACKAGE	PKG. PART #	PARTITION PART #
GM STANDARD WHEEL BASE	4007C	40640 + 4064C
FORD TRANSIT STANDARD WHEEL BASE LOW ROOF	47TRL	40640 + 406TL
FORD TRANSIT LONG WHEEL BASE LOW ROOF	48 TLL	40640 + 406TL

**IMPORTANT.** THESE PARTITION PARTS ARE INCLUDED IN EACH PACKAGE, AND ARE REQUIRED TO BUILD A PACKAGE.

### STANDARD WHEEL BASE PACKAGES INCLUDE

Item	Qty.	Part#	Description	Item	Qty.	Part#	Description
1	(1)		Partition & Wing Kit (see above)	5	(1)	40250	Steel Long 3 Drawer
2	(2)	48420	42"W Adjustable Shelf	6	(1)	40260	Rotating Wheel Well Stand
3	(1)	40030	Shelf Dividers (Set of 6)	7	(4)	40310	Plastic Shelf Bin
4	(1)	40060	3-Prong "J" Hook				

### LONG WHEEL BASE PACKAGES INCLUDE

Item	Qty.	Part#	Description	Item	Qty.	Part#	Description
1	(1)		Partition & Wing Kit (see above)	5	(1)	40250	Steel Long 3 Drawer
2	(2)	48520	52"W Adjustable Shelf	6	(1)	40260	Rotating Wheel Well Stand
3	(1)	40030	Shelf Dividers (Set of 6)	7	(4)	40310	Plastic Shelf Bin
4	(1)	40060	3-Prong "J" Hook				



Optional  
Center Panel Lock  
& Door Lock Kit,  
Part #40620  
(see page 8)

GM EXPRESS STANDARD WHEEL BASE PART #4007C ILLUSTRATED

## EZ ALL TRADES PACKAGES 46" H Shelves

PACKAGE	PKG. PART #	PARTITION PART #
GM STANDARD WHEEL BASE	4012C	40640 + 4064C
FORD TRANSIT STANDARD WHEEL BASE LOW ROOF	49TRL	40640 + 406TL
FORD TRANSIT LONG WHEEL BASE LOW ROOF	46TLL	40640 + 406TL
NISSAN NV STANDARD WHEEL BASE	49NVL	40640 + 406NL

**IMPORTANT.** THESE PARTITION PARTS ARE INCLUDED IN EACH PACKAGE, AND ARE REQUIRED TO BUILD A PACKAGE.

### STANDARD WHEEL BASE PACKAGES INCLUDE

Item	Qty.	Part #	Description	Item	Qty.	Part #	Description
1	(1)		Partition & Wing Kit (see above)	3	(1)	40250	Steel Long 3 Drawer
2	(3)	48420	42"W Adjustable Shelf	4	(4)	40310	Plastic Shelf Bin

### LONG WHEEL BASE PACKAGES INCLUDE

Item	Qty.	Part #	Description	Item	Qty.	Part #	Description
1	(1)		Partition & Wing Kit (see above)	3	(1)	40250	Steel Long 3 Drawer
2	(3)	48520	52"W Adjustable Shelf	4	(4)	40310	Plastic Shelf Bin

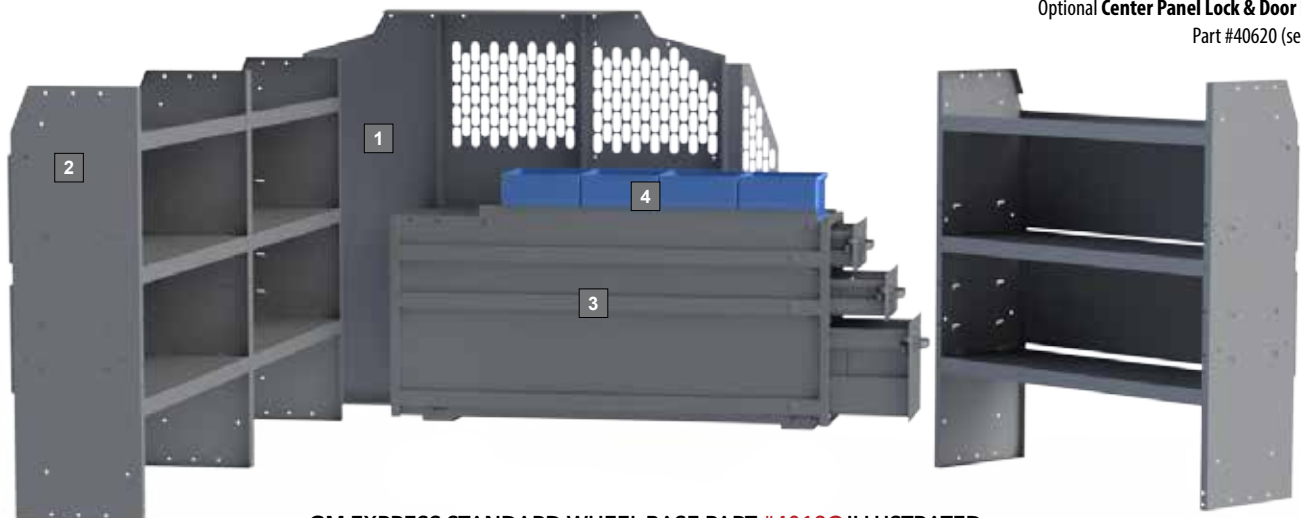

Optional Center Panel Lock & Door Lock Kit,  
Part #40620 (see page 8)

GM EXPRESS STANDARD WHEEL BASE PART #4012C ILLUSTRATED

# LOW ROOF Full-Sized Van Packages

## GENERAL CONTRACTOR PACKAGES 46" H Shelves

PACKAGE	PKG. PART #	PARTITION PART #
GM STANDARD WHEEL BASE	4002C	40640 + 4064C
FORD TRANSIT STANDARD WHEEL BASE LOW ROOF	42TRL	40640 + 406TL

**IMPORTANT.** THESE PARTITION PARTS ARE INCLUDED IN EACH PACKAGE, AND ARE REQUIRED TO BUILD A PACKAGE.

### STANDARD WHEEL BASE PACKAGES INCLUDE

Item	Qty.	Part#	Description	Item	Qty.	Part#	Description
1	(1)		Partition & Wing Kit (see above)	7	(1)	40280	Standing Binder Rack
2	(2)	48420	42" W Adjustable Shelf	8	(1)	40010	42" W Shelf Door Kit
3	(1)	48520	52" W Adjustable Shelf	9	(1)	40040	52" W Shelf Door Kit
4	(1)	40070	Steel 2 Drawer Cabinet	10	(1)	48220	Floor Angle Shelp Lip
5	(1)	40080	Steel 3 Drawer Cabinet	11	(2)	40060	3-Prong "J" Hook
6	(4)	40030	Shelf Dividers (Set of 6)				

Optional Center Panel Lock & Door Lock Kit, Part #40620 (see page 8)



GM EXPRESS STANDARD WHEEL BASE PART #4002C ILLUSTRATED

## AMERICA'S MOST POPULAR PACKAGES 46" H Shelves

PACKAGE	PKG. PART #	PARTITION PART #
GM STANDARD WHEEL BASE	4011C	40640 + 4064C
FORD TRANSIT STANDARD WHEEL BASE LOW ROOF	48TRL	40640 + 406TL
FORD TRANSIT LONG WHEEL BASE LOW ROOF	47TLL	40640 + 406TL

**IMPORTANT.** THESE PARTITION PARTS ARE INCLUDED IN EACH PACKAGE, AND ARE REQUIRED TO BUILD A PACKAGE.

### STANDARD WHEEL BASE PACKAGES INCLUDE

Item	Qty.	Part #	Description	Item	Qty.	Part #	Description
1	(1)		Partition & Wing Kit (see above)	5	(2)	40080	Steel 3 Drawer Cabinet
2	(2)	48420	42" W Adjustable Shelf	6	(1)	40010	42" W Shelf Door Kit
3	(1)	48320	32" W Adjustable Shelf	7	(1)	40280	Standing Binder Rack
4	(1)	40220	Cabinet Locker Full Door	8	(1)	40060	3-Prong "J" Hook

### LONG WHEEL BASE PACKAGES INCLUDE

Item	Qty.	Part #	Description	Item	Qty.	Part #	Description
1	(1)		Partition & Wing Kit (see above)	5	(2)	40080	Steel 3 Drawer Cabinet
2	(3)	48520	52" W Adjustable Shelf	6	(1)	40040	52" W Shelf Door Kit
	(1)	48190	10" W Shelf Lip	7	(1)	40280	Standing Binder Rack
4	(1)	40220	Cabinet Locker Full Drawer	8	(1)	40060	3-Prong "J" Hook

Optional Center Panel Lock & Door Lock Kit, Part #40620 (see page 8)



GM EXPRESS STANDARD WHEEL BASE PART #4011C ILLUSTRATED

(800) 343-7486

**KARGO MASTER**

P16 VISIT [KARGOMASTER.COM](http://KARGOMASTER.COM) FOR MORE INFORMATION

TRUCK RACKS & CARGO VAN EQUIPMENT

## CABLE PACKAGES 46" H Shelves

PACKAGE	PKG. PART #	PARTITION PART #
FORD TRANSIT LONG WHEEL BASE LOW ROOF	44TLL	40640 + 406TL

**IMPORTANT.** THESE PARTITION PARTS ARE INCLUDED IN EACH PACKAGE, AND ARE REQUIRED TO BUILD A PACKAGE.

Optional Center Panel Lock & Door Lock Kit,  
Part #40620 (see page 8)

### ▶ LONG WHEEL BASE PACKAGES INCLUDE ◀

Item	Qty.	Part#	Description	Item	Qty.	Part#	Description
1	(1)		Partition & Wing Kit (see above)	5	(1)	40040	52"W Shelf Door Kit
2	(3)	48520	52"W Adjustable Shelf	6	(2)	40070	Steel 2 Drawer Cabinet
3	(1)	40030	Shelf Dividers (Set of 6)	7	(2)	40060	3-Prong "J" Hook
4	(1)	48190	10"W Shelf Lip				



FORD TRANSIT LONG WHEEL BASE PART #44TLL ILLUSTRATED

## SECURITY PACKAGES 46" H Shelves

PACKAGE	PKG. PART #	PARTITION PART #
FORD TRANSIT LONG WHEEL BASE LOW ROOF	43TLL	40640 + 406TL

**IMPORTANT.** THESE PARTITION PARTS ARE INCLUDED IN EACH PACKAGE, AND ARE REQUIRED TO BUILD A PACKAGE.

Optional Center Panel Lock & Door Lock Kit,  
Part #40620 (see page 8)

### ▶ LONG WHEEL BASE PACKAGES INCLUDE ◀

Item	Qty.	Part #	Description	Item	Qty.	Part #	Description
1	(1)		Partition & Wing Kit (see above)	6	(2)	40060	3-Prong "J" Hook
2	(3)	48520	52"W Adjustable Shelf	7	(2)	40070	Steel 2 Drawer Cabinet
3	(2)	40040	52"W Shelf Door Kit	8	(1)	40270	Hanging File Rack
4	(2)	40030	Shelf Dividers (Set of 6)	9	(1)	48190	10"W Shelf Lip
5	(5)	40310	Plastic Shelf Bin				



FORD TRANSIT LONG WHEEL BASE PART #43TLL ILLUSTRATED

# MID/HIGH ROOF Full-Sized Van Packages

## BASE PACKAGES 60" H Shelves

PACKAGE	PKG. PART #	PARTITION PART #
FORD TRANSIT STANDARD WHEEL BASE MID/HIGH ROOF	40TRM	40651 + 406TH
FORD TRANSIT LONG WHEEL BASE MID/HIGH ROOF	40TLM	40651 + 406TH
RAM PROMASTER STANDARD WHEEL BASE	40PMS	40651 + 4064P
RAM PROMASTER LONG WHEEL BASE LOW ROOF	40PML	40651 + 4064P
NISSAN NV STANDARD WHEEL BASE HIGH ROOF	40NVH	40651 + 406NH
SPRINTER STANDARD WHEEL BASE LOW ROOF	40SPL	40651 + 406SL
SPRINTER LONG WHEEL BASE HIGH ROOF (*includes wing kit)	40SPH	4061S*

**IMPORTANT.** THESE PARTITION PARTS ARE INCLUDED IN EACH PACKAGE, AND ARE REQUIRED TO BUILD A PACKAGE.

### STANDARD WHEEL BASE PACKAGES INCLUDE

Item Qty.	Part#	Description	Item Qty.	Part#	Description
1	(1)	Partition & Wing Kit (see above)	2	(3) 48424	42"W Adjustable Shelf

### LONG WHEEL BASE PACKAGES INCLUDE

Item Qty.	Part#	Description	Item Qty.	Part#	Description
1	(1)	Partition & Wing Kit (see above)	2	(3) 48524	52"W Adjustable Shelf



RAM PROMASTER STANDARD WHEEL BASE PART #40PMS ILLUSTRATED

Optional  
Center Panel Lock  
& Door Lock Kit,  
Part #40620  
(see page 8)

## GENERAL SERVICE PACKAGES 60" H Shelves

PACKAGE	PKG. PART #	PARTITION PART #
FORD TRANSIT STANDARD WHEEL BASE MID/HIGH ROOF	41TRM	40651 + 406TH
FORD TRANSIT LONG WHEEL BASE MID/HIGH ROOF	41TLM	40651 + 406TH
RAM PROMASTER STANDARD WHEEL BASE	41PMS	40651 + 4064P
RAM PROMASTER LONG WHEEL BASE LOW ROOF	41PML	40651 + 4064P
NISSAN NV STANDARD WHEEL BASE HIGH ROOF	41NVH	40651 + 406NH
SPRINTER STANDARD WHEEL BASE LOW ROOF	41SPL	40651 + 406SL
SPRINTER LONG WHEEL BASE HIGH ROOF (*includes wing kit)	41SPH	4061S

**IMPORTANT.** THESE PARTITION PARTS ARE INCLUDED IN EACH PACKAGE, AND ARE REQUIRED TO BUILD A PACKAGE.

### STANDARD WHEEL BASE PACKAGES INCLUDE

Item Qty.	Part #	Description	Item Qty.	Part #	Description
1	(1)	Partition & Wing Kit (see above)	5	(2) 40060	3-Prong "J" Hook
2	(3) 48424	42"W Adjustable Shelf	6	(1) 40080	Steel 3 Drawer Cabinet
3	(5) 40310	Plastic Shelf Bin	7	(1) 40090	Steel 4 Drawer Cabinet
4	(1) 40030	Shelf Dividers (Set of 6)			

### LONG WHEEL BASE PACKAGES INCLUDE

Item Qty.	Part #	Description	Item Qty.	Part #	Description
1	(1)	Partition & Wing Kit (see above)	5	(2) 40060	3-Prong "J" Hook
2	(3) 48524	52"W Adjustable Shelf	6	(1) 40080	Steel 3 Drawer Cabinet
3	(5) 40310	Plastic Shelf Bin	7	(1) 40090	Steel 4 Drawer Cabinet
4	(1) 40030	Shelf Dividers (Set of 6)	(1)	48190	10"W Shelf Lip (not shown)



RAM PROMASTER STANDARD WHEEL BASE PART #41PMS ILLUSTRATED

Optional  
Center Panel Lock  
& Door Lock Kit,  
Part #40620  
(see page 8)

(800) 343-7486

**KARGO MASTER**

P18 VISIT [KARGOMASTER.COM](http://KARGOMASTER.COM) FOR MORE INFORMATION

TRUCK RACKS & CARGO VAN EQUIPMENT

## CABLE PACKAGES 60" H Shelves

PACKAGE	PKG. PART #	PARTITION PART #
FORD TRANSIT STANDARD WHEEL BASE MID/HIGH ROOF	44TRM	40651 + 406TH
FORD TRANSIT LONG WHEEL BASE MID/HIGH ROOF	44TLM	40651 + 406TH
RAM PROMASTER STANDARD WHEEL BASE LOW/HIGH ROOF	44PMS	40651 + 4064P
RAM PROMASTER LONG WHEEL BASE LOW/HIGH ROOF	44PML	40651 + 4064P

**IMPORTANT.** THESE PARTITION PARTS ARE INCLUDED IN EACH PACKAGE, AND ARE REQUIRED TO BUILD A PACKAGE.

### STANDARD WHEEL BASE PACKAGES INCLUDE ◀

Item	Qty.	Part#	Description	Item	Qty.	Part#	Description
1	(1)		Partition & Wing Kit (see above)	4	(1)	40030	Shelf Dividers (Set of 6)
2	(3)	48424	42"W Adjustable Shelf	5	(1)	40010	42" Shelf Door Kit
3	(2)	40070	Steel 2 Drawer Cabinet	6	(2)	40060	3-Prong "J" Hook

### LONG WHEEL BASE PACKAGES INCLUDE ◀

Item	Qty.	Part#	Description	Item	Qty.	Part#	Description
1	(1)		Partition & Wing Kit (see above)	4	(1)	40030	Shelf Dividers (Set of 6)
2	(3)	48524	52"W Adjustable Shelf	5	(1)	40040	52" Shelf Door Kit
3	(2)	40070	Steel 2 Drawer Cabinet	6	(2)	40060	3-Prong "J" Hook
				7	(1)	48190	10" L Shelf Lip (not shown)

Optional Center Panel Lock & Door Lock Kit, Part #40620 (see page 8)



RAM PROMASTER STANDARD WHEEL BASE PART #44PMS ILLUSTRATED

## SECURITY PACKAGES 60" H Shelves

PACKAGE	PKG. PART #	PARTITION PART #
FORD TRANSIT STANDARD WHEEL BASE MID/HIGH ROOF	43TRM	40651 + 406TH
FORD TRANSIT LONG WHEEL BASE MID/HIGH ROOF	43TLM	40651 + 406TH
RAM PROMASTER STANDARD WHEEL BASE LOW/HIGH ROOF	43PMS	40651 + 4064P
RAM PROMASTER LONG WHEEL BASE LOW/HIGH ROOF	43PML	40651 + 4064P

**IMPORTANT.** THESE PARTITION PARTS ARE INCLUDED IN EACH PACKAGE, AND ARE REQUIRED TO BUILD A PACKAGE.

### STANDARD WHEEL BASE PACKAGES INCLUDE ◀

Item	Qty.	Part #	Description	Item	Qty.	Part #	Description
1	(1)		Partition & Wing Kit (see above)	5	(4)	40310	10"W Plastic Bin
2	(3)	48424	42"W Adjustable Shelf	6	(2)	40060	3-Prong "J" Hook
3	(2)	40010	42"W Shelf Door Kit	7	(2)	40070	Steel 2 Drawer Cabinet
4	(2)	40030	Shelf Dividers (Set of 6)	8	(1)	40270	Hanging File Rack

### LONG WHEEL BASE PACKAGES INCLUDE ◀

Item	Qty.	Part #	Description	Item	Qty.	Part #	Description
1	(1)		Partition & Wing Kit (see above)	5	(5)	40310	10"W Plastic Bin
2	(3)	48524	52"W Adjustable Shelf	6	(2)	40060	3-Prong "J" Hook
3	(2)	40040	52"W Shelf Door Kit	7	(2)	40070	Steel 2 Drawer Cabinet
4	(2)	40030	Shelf Dividers (Set of 6)	8	(1)	40270	Hanging File Rack
				(1)		48190	10" L Shelf Lip (not shown)

Optional Center Panel Lock & Door Lock Kit, Part #40620 (see page 8)



RAM PROMASTER STANDARD WHEEL BASE PART #43PMS ILLUSTRATED

# MID/HIGH ROOF Full-Sized Van Packages

## HVAC PACKAGES 60" H Shelves

PACKAGE	PKG. PART #	PARTITION PART #
FORD TRANSIT STANDARD WHEEL BASE MID/HIGH ROOF	45TRM	40651 + 406TH
FORD TRANSIT LONG WHEEL BASE MID/HIGH ROOF	45TLM	40651 + 406TH
RAM PROMASTER STANDARD WHEEL BASE LOW/HIGH ROOF	45PMS	40651 + 4064P
RAM PROMASTER LONG WHEEL BASE LOW/HIGH ROOF	45PML	40651 + 4064P
NISSAN STANDARD WHEEL BASE HIGH ROOF	45NVH	40651 + 406NH
SPRINTER STANDARD WHEEL BASE LOW ROOF	45SPL	40651 + 40SRL
SPRINTER LONG WHEEL BASE HIGH ROOF (*includes wing kit)	45SPH	4061S

**IMPORTANT.** THESE PARTITION PARTS ARE INCLUDED IN EACH PACKAGE, AND ARE REQUIRED TO BUILD A PACKAGE.

### STANDARD WHEEL BASE PACKAGES INCLUDE

Item Qty.	Part#	Description	Item Qty.	Part#	Description
1	(1)	Partition & Wing Kit (see above)	6	(1)	40200 Refrigerant Tank Rank
2	(3)	48424 42" W Adjustable Shelf	7	(2)	40070 Steel 2 Drawer Cabinet
3	(1)	40030 Shelf Dividers (Set of 6)	8	(1)	40060 3-Prong "J" Hook
4	(4)	40310 10" W Plastic Bin	9	(1)	40270 Hanging File Rack
5	(1)	40010 42" W Shelf Door Kit			

### LONG WHEEL BASE PACKAGES INCLUDE

Item Qty.	Part#	Description	Item Qty.	Part#	Description
1	(1)	Partition & Wing Kit (see above)	6	(1)	40200 Refrigerant Tank Rank
2	(3)	48524 52" W Adjustable Shelf	7	(2)	40070 Steel 2 Drawer Cabinet
3	(1)	40030 Shelf Dividers (Set of 6)	8	(1)	40060 3-Prong "J" Hook
4	(5)	40310 10" W Plastic Bin	9	(1)	40270 Hanging File Rack
5	(1)	40040 52" W Shelf Door Kit	10	(1)	48190 10" L Shelf Lip (not shown)



RAM PROMASTER STANDARD WHEEL BASE PART #45PMS ILLUSTRATED

Optional  
Center Panel Lock  
& Door Lock Kit,  
Part #40620  
(see page 8)

## ELECTRICAL CONTRACTOR PACKAGES 60" H Shelves

PACKAGE	PKG. PART #	PARTITION PART #
FORD TRANSIT STANDARD WHEEL BASE MID/HIGH ROOF	42TRM	40651 + 406TH
FORD TRANSIT LONG WHEEL BASE MID/HIGH ROOF	42TLM	40651 + 406TH
RAM PROMASTER STANDARD WHEEL BASE LOW/HIGH ROOF	42PMS	40651 + 4064P
RAM PROMASTER LONG WHEEL BASE LOW/HIGH ROOF	42PML	40651 + 4064P

**IMPORTANT.** THESE PARTITION PARTS ARE INCLUDED IN EACH PACKAGE, AND ARE REQUIRED TO BUILD A PACKAGE.

### STANDARD WHEEL BASE PACKAGES INCLUDE

Item Qty.	Part #	Description	Item Qty.	Part #	Description
1	(1)	Partition & Wing Kit (see above)	6	(1)	40230 Wire Reel Holder 5 Spindle
2	(3)	48424 42" W Adjustable Shelf	7	(1)	40270 Hanging File Rack
3	(8)	40310 10" W Plastic Bin	8	(2)	40090 Steel 4 Drawer Cabinet
4	(1)	40030 Shelf Dividers (Set of 6)	9	(1)	40060 3-Prong "J" Hook
5	(2)	40010 42" W Shelf Door Kit			

### LONG WHEEL BASE PACKAGES INCLUDE

Item Qty.	Part #	Description	Item Qty.	Part #	Description
1	(1)	Partition & Wing Kit (see above)	6	(1)	40230 Wire Reel Holder 5 Spindle
2	(3)	48524 52" W Adjustable Shelf	7	(2)	40270 Hanging File Rack
3	(10)	40310 10" W Plastic Bin	8	(2)	40090 Steel 4 Drawer Cabinet
4	(1)	40030 Shelf Dividers (Set of 6)	9	(1)	40060 3-Prong "J" Hook
5	(2)	40040 52" W Shelf Door Kit	(1)	48190	10" L Shelf Lip (not shown)



RAM PROMASTER STANDARD WHEEL BASE PART #42PMS ILLUSTRATED

Optional  
Center Panel Lock  
& Door Lock Kit,  
Part #40620  
(see page 8)

(800) 343-7486

P20 VISIT [KARGOMASTER.COM](http://KARGOMASTER.COM) FOR MORE INFORMATION

**KARGO MASTER**

TRUCK RACKS & CARGO VAN EQUIPMENT

# MID/HIGH ROOF Full-Sized Van Packages

## EZ ALL TRADES PACKAGES 60" H Shelves

PACKAGE	PKG. PART #	PARTITION PART #
FORD TRANSIT STANDARD WHEEL BASE MID/HIGH ROOF	46TRM	40651 + 406TH
FORD TRANSIT LONG WHEEL BASE MID/HIGH ROOF	46TLM	40651 + 406TH
RAM PROMASTER STANDARD WHEEL BASE	46PMS	40651 + 4064P
RAM PROMASTER LONG WHEEL BASE	46PML	40651 + 4064P
NISSAN NV STANDARD WHEEL BASE HIGH ROOF	46NVH	40651 + 406NH
SPRINTER STANDARD WHEEL BASE LOW ROOF	46SPL	40651 + 406SL
SPRINTER LONG WHEEL BASE HIGH ROOF (*includes wing kit)	46SPH	4061S*

**IMPORTANT.** THESE PARTITION PARTS ARE INCLUDED IN EACH PACKAGE, AND ARE REQUIRED TO BUILD A PACKAGE.

### STANDARD WHEEL BASE PACKAGES INCLUDE

Item Qty.	Part#	Description	Item Qty.	Part#	Description
1 (1)		Partition & Wing Kit (see above)	3 (1)	40250	Steel 3 Long Drawers
2 (3)	48424	42"W Adjustable Shelf	4 (4)	40310	Plastic Shelf Bin

### LONG WHEEL BASE PACKAGES INCLUDE

Item Qty.	Part#	Description	Item Qty.	Part#	Description
1 (1)		Partition & Wing Kit (see above)	3 (1)	40250	Steel 3 Long Drawers
2 (3)	48524	52"W Adjustable Shelf	4 (4)	40310	Plastic Shelf Bin



FORD TRANSIT STANDARD WHEEL BASE PART #46TRM ILLUSTRATED

Optional  
Center Panel Lock  
& Door Lock Kit,  
Part #40620  
(see page 8)

## AMERICA'S MOST POPULAR PACKAGES 60" H Shelves

PACKAGE	PKG. PART #	PARTITION PART #
FORD TRANSIT LONG WHEEL BASE MID/HIGH ROOF	47TLM	40651 + 406TH
RAM PROMASTER STANDARD WHEEL BASE	47PMS	40651 + 4064P
RAM PROMASTER LONG WHEEL BASE	47PML	40651 + 4064P

**IMPORTANT.** THESE PARTITION PARTS ARE INCLUDED IN EACH PACKAGE, AND ARE REQUIRED TO BUILD A PACKAGE.

### STANDARD WHEEL BASE PACKAGES INCLUDE

Item Qty.	Part#	Description	Item Qty.	Part#	Description
1 (1)		Partition & Wing Kit (see above)	5 (1)	40010	42"W Door Kit
2 (3)	48424	42"W Adjustable Shelf	6 (1)	40280	Standing Binder Rack
3 (1)	40220	Cabinet Locker Full Door	7 (1)	40060	3-Prong "J" Hook
4 (2)	40080	Steel 3 Drawer Cabinet			

### LONG WHEEL BASE PACKAGES INCLUDE

Item Qty.	Part#	Description	Item Qty.	Part#	Description
1 (1)		Partition & Wing Kit (see above)	5 (1)	40040	52"W Shelf Door Kit
2 (3)	48524	52"W Adjustable Shelf	6 (1)	40280	Standing Binder Rack
3 (1)	40220	Cabinet Locker Full Door	7 (1)	40060	3-Prong "J" Hook
4 (2)	40080	Steel 3 Drawer Cabinet	8 (1)	48190	10"W Shelf Lip (not shown)

Optional Center Panel Lock & Door Lock Kit, Part #40620 (see page 8)



RAM PROMASTER STANDARD WHEEL BASE PART #47PMS ILLUSTRATED

# MINI CARGO Van Packages

## COMMERCIAL SHELVING PACKAGES Sheet Metal Partition 46" H

PACKAGE	PKG. PART #	PARTITION PART #
FORD TRANSIT CONNECT <b>SHORT WHEEL BASE</b>	40TCS	40667
FORD TRANSIT CONNECT <b>LONG WHEEL BASE</b>	40TCL	40667
CHEVY CITY EXPRESS	400CE	40667
NISSAN NV200	400CE	40667
RAM PROMASTER CITY	400PC	40667

**IMPORTANT.** THESE PARTITION PARTS ARE INCLUDED IN EACH PACKAGE, AND ARE REQUIRED TO BUILD A PACKAGE.

### STANDARD WHEEL BASE PACKAGES INCLUDE

Item Qty.	Part#	Description	Item Qty.	Part#	Description
1	(1)	Partition (see above)	2	(2)	4826T 26"W Adjustable Shelf

### LONG WHEEL BASE PACKAGES INCLUDE

Item Qty.	Part#	Description	Item Qty.	Part#	Description
1	(1)	Partition (see above)	2	(2)	4832M 32"W Adjustable Shelf



Swap **New Wire Partition**, Part #40668 for #40667 (see page 2)

CHEVY CITY EXPRESS PART #400CE ILLUSTRATED

## COMMERCIAL SHELVING PACKAGES Wire Partition 46" H

PACKAGE	PKG. PART #	PARTITION PART #
FORD TRANSIT CONNECT <b>SHORT WHEEL BASE</b>	47TCS	40668
FORD TRANSIT CONNECT <b>LONG WHEEL BASE</b>	47TCL	40668
CHEVY CITY EXPRESS	407CE	40668
NISSAN NV200	407CE	40668

**IMPORTANT.** THESE PARTITION PARTS ARE INCLUDED IN EACH PACKAGE, AND ARE REQUIRED TO BUILD A PACKAGE.

### STANDARD WHEEL BASE PACKAGES INCLUDE

Item Qty.	Part#	Description	Item Qty.	Part#	Description
1	(1)	Partition (see above)	2	(2)	4826T 26"W Adjustable Shelf

### LONG WHEEL BASE PACKAGES INCLUDE

Item Qty.	Part#	Description	Item Qty.	Part#	Description
1	(1)	Partition (see above)	2	(2)	4832M 32"W Adjustable Shelf



FORD TRANSIT CONNECT LONG WHEEL BASE PART #47TCL ILLUSTRATED

(800) 343-7486

P22 VISIT [KARGOMASTER.COM](http://KARGOMASTER.COM) FOR MORE INFORMATION

**KARGO MASTER**

TRUCK RACKS & CARGO VAN EQUIPMENT

## DELUXE COMMERCIAL SHELVING PACKAGES 46" H Shelves

PACKAGE	PKG. PART #	PARTITION PART #
FORD TRANSIT CONNECT <b>LONG WHEEL BASE</b>	41TCL	40667
CHEVY CITY EXPRESS	401CE	40667
NISSAN NV200	401CE	40667
RAM PROMASTER CITY	401PC	406PC

**IMPORTANT.** THESE PARTITION PARTS ARE INCLUDED IN EACH PACKAGE, AND ARE REQUIRED TO BUILD A PACKAGE.

### STANDARD WHEEL BASE PACKAGES INCLUDE ◀

Item Qty.	Part#	Description	Item Qty.	Part#	Description
1	(1)	Partition (see above)	4	(1)	40060 3-Prong "J" Hook
2	(2)	4832M 32" W Adjustable Shelf	5	(1)	40030 Shelf Dividers (Set of 6)
3	(1)	4826T 26" W Adjustable Shelf			

### LONG WHEEL BASE PACKAGES INCLUDE ◀

Item Qty.	Part#	Description	Item Qty.	Part#	Description
1	(1)	Partition (see above)	3	(1)	40060 3-Prong "J" Hook
2	(3)	4832M 32" W Adjustable Shelf	5	(1)	40030 Shelf Dividers (Set of 6)

Swap **New Wire Partition**, Part #40668 for #40667 (see page 2)



FORD TRANSIT CONNECT LONG WHEEL BASE PART #41TCL ILLUSTRATED

## HVAC PACKAGES 46" H Shelves

PACKAGE	PKG. PART #	PARTITION PART #
FORD TRANSIT CONNECT <b>LONG WHEEL BASE</b>	45TCL	40667
CHEVY CITY EXPRESS	405CE	40667
NISSAN NV200	405CE	40667
RAM PROMASTER CITY	405PC	406PC

**IMPORTANT.** THESE PARTITION PARTS ARE INCLUDED IN EACH PACKAGE, AND ARE REQUIRED TO BUILD A PACKAGE.

### STANDARD WHEEL BASE PACKAGES INCLUDE ◀

Item Qty.	Part #	Description	Item Qty.	Part #	Description
1	(1)	Partition (see above)	6	(1)	48180 20" L Shelf Lip
2	(1)	48420 42" W Adjustable Shelf	7	(1)	40200 Refrigerant Tank Rack
3	(1)	4832M 32" W Adjustable Shelf	8	(3)	40310 Plastic Shelf Bin
4	(2)	40080 Steel 3 Drawer Cabinet	9	(1)	40060 3-Prong "J" Hook
5	(2)	48240 Plastic Shelf Bin Module			

### LONG WHEEL BASE PACKAGES INCLUDE ◀

Item Qty.	Part #	Description	Item Qty.	Part #	Description
1	(1)	Partition (see above)	5	(2)	48250 Plastic Shelf Bin Module
2	(2)	4826T 26" W Adjustable Shelf	6	(1)	40200 Refrigerant Tank Rack
3	(1)	4832M 32" W Adjustable Shelf	7	(3)	40310 Plastic Shelf Bin
4	(2)	40080 Steel 3 Drawer Cabinet	8	(1)	40060 3-Prong "J" Hook

Swap **New Wire Partition**, Part #40668 for #40667 (see page 2)



FORD TRANSIT CONNECT LONG WHEEL BASE PART #45TCL ILLUSTRATED

# MINI CARGO Van Packages

## GENERAL SERVICE PACKAGES 46" H Shelves

PACKAGE	PKG. PART #	PARTITION PART #
FORD TRANSIT CONNECT <b>SHORT WHEEL BASE</b>	41TCS	40667
FORD TRANSIT CONNECT <b>LONG WHEEL BASE</b>	42TCL	40667
CHEVY CITY EXPRESS	402CE	40667
NISSAN NV200	402CE	40667
RAM PROMASTER CITY	402PC	406PC

**IMPORTANT.** THESE PARTITION PARTS ARE INCLUDED IN EACH PACKAGE, AND ARE REQUIRED TO BUILD A PACKAGE.

### STANDARD WHEEL BASE PACKAGES INCLUDE

Item	Qty.	Part#	Description	Item	Qty.	Part#	Description
1	(1)		Partition (see above)	5	(1)	40020	32"W Shelf Door Kit
2	(1)	48420	42"W Adjustable Shelf	6	(1)	40060	3-Prong "J" Hook
3	(1)	4826T	26"W Adjustable Shelf	7	(1)	40080	Steel 3 Drawer Cabinet
4	(1)	48240	Plastic Shelf Bin Module				

### LONG WHEEL BASE PACKAGES INCLUDE

Item	Qty.	Part#	Description	Item	Qty.	Part#	Description
1	(1)		Partition (see above)	4	(1)	40020	32"W Shelf Door Kit
2	(4)	4832M	32"W Adjustable Shelf	5	(1)	40060	3-Prong "J" Hook
3	(1)	48240	Plastic Shelf Bin Module	6	(2)	40080	Steel 3 Drawer Cabinet
				7	(2)	48250	Plastic Shelf Bin



FORD TRANSIT CONNECT SHORT WHEEL BASE PART #41TCS ILLUSTRATED

Swap **New Wire Partition**, Part #40668 for #40667 (see page 2)

## ELECTRICAL CONTRACTOR PACKAGES 46" H Shelves

PACKAGE	PKG. PART #	PARTITION PART #
FORD TRANSIT CONNECT <b>LONG WHEEL BASE</b>	44TCL	40667
CHEVY CITY EXPRESS	404CE	40667
NISSAN NV200	404CE	40667
RAM PROMASTER CITY	404PC	406PC

**IMPORTANT.** THESE PARTITION PARTS ARE INCLUDED IN EACH PACKAGE, AND ARE REQUIRED TO BUILD A PACKAGE.

### STANDARD WHEEL BASE PACKAGES INCLUDE

Item	Qty.	Part#	Description	Item	Qty.	Part#	Description
1	(1)		Partition (see above)	5	(1)	40060	3-Prong "J" Hook
2	(2)	4832M	32"W Adjustable Shelf	6	(1)	40020	32"W Shelf Door Kit
3	(1)	4826T	26"W Adjustable Shelf	7	(1)	40080	Steel 3 Drawer Cabinet
4	(6)	40310	Plastic Shelf Bin	8	(1)	48250	Plastic Shelf Bin Module

### LONG WHEEL BASE PACKAGES INCLUDE

Item	Qty.	Part#	Description	Item	Qty.	Part#	Description
1	(1)		Partition (see above)	4	(1)	40060	3-Prong "J" Hook
2	(3)	4832M	32"W Adjustable Shelf	5	(1)	40020	32"W Shelf Door Kit
3	(6)	40310	Plastic Shelf Bin	6	(1)	40080	Steel 3 Drawer Cabinet
				7	(1)	48250	Plastic Shelf Bin Module



FORD TRANSIT CONNECT LONG WHEEL BASE PART #44TCL ILLUSTRATED

Swap **New Wire Partition**, Part #40668 for #40667 (see page 2)

(800) 343-7486

**KARGO MASTER**

P24 VISIT [KARGOMASTER.COM](http://KARGOMASTER.COM) FOR MORE INFORMATION

TRUCK RACKS & CARGO VAN EQUIPMENT

## PLUMBING PACKAGES 46" H Shelves

PACKAGE	PKG. PART #	PARTITION PART #
FORD TRANSIT CONNECT <b>LONG WHEEL BASE</b>	43TCL	40667
CHEVY CITY EXPRESS	403CE	40667
NISSAN NV200	403CE	40667
RAM PROMASTER CITY	403PC	406PC

**IMPORTANT.** THESE PARTITION PARTS ARE INCLUDED IN EACH PACKAGE, AND ARE REQUIRED TO BUILD A PACKAGE.

### STANDARD WHEEL BASE PACKAGES INCLUDE

Item	Qty.	Part #	Description	Item	Qty.	Part #	Description
1	(1)		Partition (see above)	5	(3)	48250	Plastic Shelf Bin Module
2	(2)	4832M	32" W Adjustable Shelf	6	(1)	40020	32" W Shelf Door Kit
3	(1)	4826T	26" W Adjustable Shelf	7	(1)	40060	3-Prong "J" Hook
4	(3)	40080	Steel 3 Drawer Cabinet	8	(3)	40310	Plastic Shelf Bin

### LONG WHEEL BASE PACKAGES INCLUDE

Item	Qty.	Part #	Description	Item	Qty.	Part #	Description
1	(1)		Partition (see above)	4	(3)	48250	Plastic Shelf Bin Module
2	(3)	4832M	32" W Adjustable Shelf	5	(1)	40020	32" W Shelf Door Kit
3	(3)	40080	Steel 3 Drawer Cabinet	6	(1)	40060	3-Prong "J" Hook
				7	(3)	40310	Plastic Shelf Bin



CHEVY CITY EXPRESS STANDARD WHEEL BASE PART #403CE ILLUSTRATED

Swap **New Wire Partition**, Part #40668 for #40667 (see page 2)

## TELECOM PACKAGES 46" H Shelves

PACKAGE	PKG. PART #	PARTITION PART #
FORD TRANSIT CONNECT <b>LONG WHEEL BASE</b>	46TCL	40667
CHEVY CITY EXPRESS	406CE	40667
NISSAN NV200	406CE	40667
RAM PROMASTER CITY	407PC	406PC

**IMPORTANT.** THESE PARTITION PARTS ARE INCLUDED IN EACH PACKAGE, AND ARE REQUIRED TO BUILD A PACKAGE.

### STANDARD WHEEL BASE PACKAGES INCLUDE

Item	Qty.	Part #	Description	Item	Qty.	Part #	Description
1	(1)		Partition (see above)	5	(2)	48250	Plastic Shelf Bin Module
2	(2)	4832M	32" W Adjustable Shelf	6	(2)	40020	32" W Shelf Door Kit
3	(1)	4826T	26" W Adjustable Shelf	7	(1)	40060	3-Prong "J" Hook
4	(2)	40080	Steel 3 Drawer Cabinet				

### LONG WHEEL BASE PACKAGES INCLUDE

Item	Qty.	Part #	Description	Item	Qty.	Part #	Description
1	(1)		Partition (see above)	4	(2)	48250	Plastic Shelf Bin Module
2	(3)	4832M	32" W Adjustable Shelf	5	(2)	40020	32" W Shelf Door Kit
3	(2)	40080	Steel 3 Drawer Cabinet	6	(1)	40060	3-Prong "J" Hook

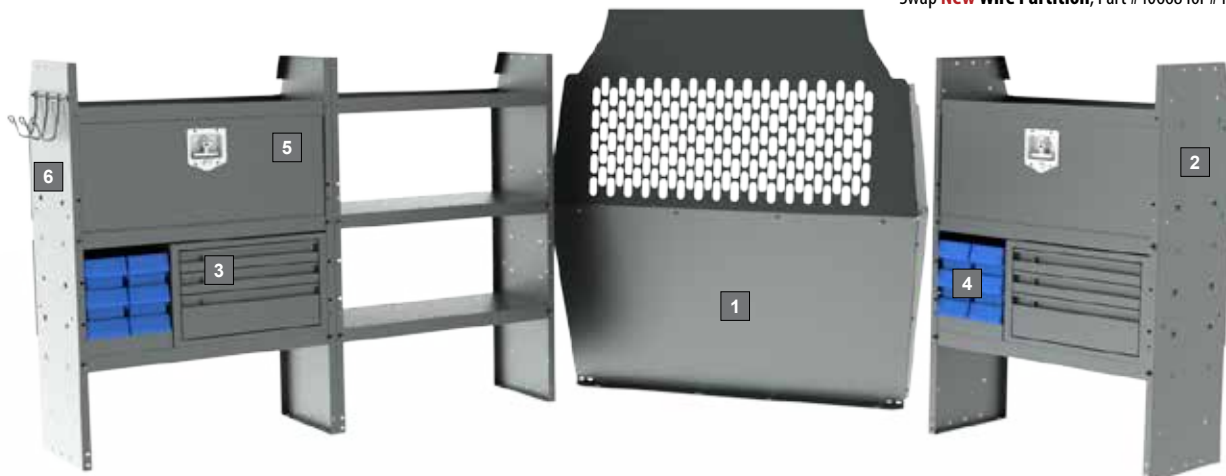

FORD TRANSIT CONNECT LONG WHEEL BASE PART #46TCL ILLUSTRATED

Swap **New Wire Partition**, Part #40668 for #40667 (see page 2)

## Kargo Master **van racks** last a lifetime.

EZ LO-DOWN LADDER RACKS P 28



CLAMP & LOCK LADDER RACKS P 29



CROSSBAR CARGO & LADDER RACKS P 30



UTILITY ECONO VAN CARGO RACKS P 31



PRO VAN II CARGO RACK P 32



VIEW THE **KARGO MASTER RACK APPLICATION GUIDE** ON PAGE 27 AND **CARGO & LADDER RACK ACCESSORIES** ON PAGE 30

For nearly 40 years ... almost a half a century ... **Kargo Master** has been known for producing superior quality ladder and cargo racks for commercial trucks.

Today, as vehicle manufacturers are building a new and expanded line of cargo vans to meet a growing demand in service industries, **Kargo Master** developers have relied upon and turned to its experience and success to manufacture some of the most innovative and affordable racks available.

**Kargo Master** offers van racks for 15 vehicles from the leading automotive companies available in 28 configurations. Whether you have, or are considering purchasing, one of the sporty and efficient new mini cargo vans, or a high roof van that carries everything including the kitchen sink, we have a rack to meet your needs.

Before you even consider another rack brand, we encourage you to look at our racks and compare the features, and costs, for yourself.

**Kargo Master** is all about ease of use, reliability, and efficiency, from the install to your daily tasks.

(800) 343-7486

P26 VISIT [KARGOMASTER.COM](http://KARGOMASTER.COM) FOR MORE INFORMATION

**KARGO MASTER**

TRUCK RACKS & CARGO VAN EQUIPMENT

# VAN CARGO & LADDER RACKS Application Guide

## VAN TYPES

Mini Cargo Vans	A   Low Roof Full-Sized Vans	B   Low Roof Full-Sized Vans	Mid Roof Full-Sized Vans	High Roof Full-Sized Vans
Ford Transit Connect Chevy City Express Nissan NV200 Ram ProMaster City	Chevy Express Ford E-Series	Ford Transit Nissan NV	Ford Transit Sprinter Ram ProMaster	Ford Transit Nissan NV Sprinter Ram ProMaster

















VAN LADDER RACK TYPES	PART #	PART #	PART #	PART #	PART #
<b>EZ LO-DOWN LADDER RACKS</b> (See page 28)					
Passenger Side Van Ladder Rack	40933	40953	40923	40973	40993
Driver Side Mechanism Only	40943	40963	40963	40983	40913

Note: 40973 and 40983 work well on a High Roof ProMaster if the operator is at least 5'10" tall with a significant cost savings versus the 40993.

CLAMP & LOCK LADDER RACKS (See page 29)					
Passenger Side Van Ladder Rack	40873	40804	40903	--	--
Driver Side Mechanism Only	40813	40813	40813	--	--

CROSSBAR CARGO & LADDER RACKS					
Mini Cargo Van 4 Crossbar Van Rack (See page 30)	80070	--	--	--	--
A   F/S 2 or 3 Crossbar Utility Econo Van Rack (See page 31)	--	40823/4	--	--	--
B   F/S 5 Crossbar Van Rack (See page 30)	--	--	80080	B   80080	--
B   F/S 2 or 3 Crossbar Utility Econo Van Rack (Transit Only)			40826/7		
F/S Pro II H/D 5 Crossbar Van Cargo Rack (See page 32)	--	40870 + 40880	--	--	--

All **Kargo Master Ladder Racks** are designed and engineered to fit the latest cargo vans.

	<b>FORD TRANSIT CONNECT</b>	<b>CHEVY CITY EXPRESS</b>	<b>NISSAN NV200</b>	<b>RAM PROMASTER CITY</b>
<b>MIN CARGO VANS</b>				
	<b>GM EXPRESS</b>	<b>FORD E-SERIES</b>		
<b>A   LOW ROOF FULL-SIZED VANS</b>				
	<b>FORD TRANSIT LOW ROOF</b>	<b>NISSAN NV LOW ROOF</b>		
<b>B   LOW ROOF FULL-SIZED VANS</b>				
	<b>FORD TRANSIT MID ROOF</b>	<b>SPRINTER LOW ROOF</b>	<b>RAM PROMASTER LOW ROOF</b>	
<b>MID ROOF FULL-SIZED VANS</b>				
	<b>FORD TRANSIT HIGH ROOF</b>	<b>NISSAN NV HIGH ROOF</b>	<b>SPRINTER HIGH ROOF</b>	<b>RAM PROMASTER HIGH ROOF</b>
<b>HIGH ROOF FULL-SIZED VANS</b>				

# EZ LO-DOWN™ Ladder Racks



**LEFT IMAGE:** LADDER RACK ON A MID ROOF VAN IS IN THE DOWN POSITION. NOTE IT IS EASY TO REACH THE DETACHABLE HANDLE WHICH CAN BE STORED INSIDE THE VAN.

**BOTTOM IMAGE:** ON LOWER ROOF VANS, WHEN THE LADDER IS UP THE HANDLE IS EASILY REACHABLE AND NEATLY TUCKS AWAY WHEN IN THE LOCKED POSITION.



Choose from several ladder rack combinations depending on the height of your van. **EZ Lo-Down Ladder Racks** are a drop down rack which work on all roof heights and make it super easy to mount, raise (or lower) and secure your ladders.

- Rugged crossbows are low over van roof to reduce overall vehicle height and to facilitate loading and unloading.
- Easy to reach lockable clamp arm firmly secures ladder to rack on low roof racks.
- Easy to reach removeable handle firmly secures ladder to rack on higher roof racks.
- Curb side clamp mechanism included. Purchase driver side drop down or clamp & lock mechanism (sold separately ... see application guide).
- Wide mount feet clamp securely to rain gutter. Feet coated at bottom to protect rain gutter paint. (Only for GM vans)
- Ladder grips are adjustable to secure extension and step ladders 8' or larger.
- Ladder racks are available for all current cargo vans. No drilling or cutting is required.
- Zinc epoxy primed for superior rust resistance. Chip resistant white powder coat.
- Quick and easy to assemble and install with mounting kit included with rack.
- Driver side load retainers are included.

**COMBO RACKS WITH BOTH EZ LO-DOWN AND CLAMP & LOCK UNITS ARE AVAILABLE FOR LOW ROOF AND MINI CARGO VANS.**

VAN & LADDER TYPES	PART #	NOTES
<b>MINI CARGO VANS</b> (Ford Transit Connect, Chevy City Express, Nissan NV200, Ram ProMaster City)		See application guide page 27.
Double EZ Lo-Down Ladder Rack	40933 + 40943	
Single EZ Lo-Down Ladder Rack	40933	
Combo Single EZ Lo-Down + Clamp & Lock Ladder Rack	40933 + 40813	See page 29.
<b>A   LOW ROOF FULL-SIZED VANS</b> (Chevy Express and Ford E-Series)		See application guide page 27.
Double EZ Lo-Down Ladder Rack	40953 + 40963	
Single EZ Lo-Down Ladder Rack	40953	
Combo Single EZ Lo-Down + Clamp & Lock Ladder Rack	40953 + 40813	See page 29.
<b>B   LOW ROOF FULL-SIZED VANS</b> (Ford Transit and Nissan NV)		See application guide page 27.
Double EZ Lo-Down Ladder Rack	40923 + 40963	
Single EZ Lo-Down Ladder Rack	40923	
Combo Single EZ Lo-Down + Clamp & Lock Ladder Rack	40923 + 40813	See page 29.
<b>MID ROOF FULL-SIZED VANS</b> (Ford Transit, Sprinter and Ram ProMaster)		See application guide page 27.
Double EZ Lo-Down Ladder Rack	40973 + 40983	
Single EZ Lo-Down Ladder Rack	40973	
<b>HIGH ROOF FULL-SIZED VANS</b> (Ford Transit, Nissan NV, Sprinter and Ram ProMaster)		See application guide page 27.
Double EZ Lo-Down Ladder Rack	40993 + 40913	
Single EZ Lo-Down Ladder Rack	40993	

(800) 343-7486

P28 VISIT [KARGOMASTER.COM](http://KARGOMASTER.COM) FOR MORE INFORMATION

**KARGO MASTER**

TRUCK RACKS & CARGO VAN EQUIPMENT



The **Kargo Master Clamp & Lock Ladder Rack** for commercial vans is uniquely designed to easily lock and secure ladders in place. The lockable clamp arm can be easily reached and locked to provide extra security. Ladder grips are adjustable to secure extension and step ladders of all sizes. The ladder rack with rugged crossbow design is low over the van roof to reduce overall vehicle height and to facilitate loading and unloading. The Clamp & Lock Ladder Rack is installed on cargo vans with wide mounting feet which clamp securely to factory mounting holes to provide maximum support and stability, and they allow for easy, no-drill installation.

**COMBO RACKS WITH BOTH EZ LO-DOWN AND CLAMP & LOCK UNITS ARE AVAILABLE FOR LOW ROOF AND MINI CARGO VANS.**

- Rugged crossbows hover just inches above the roof to reduce overall vehicle height and to facilitate loading and unloading.
- Easy to reach lockable clamp arm firmly secures ladder to rack.
- Wide mount feet clamp securely to the van roof in factory mounting hole. Feet are coated at bottom.
- Ladder hooks are adjustable to secure extension and step ladders of all sizes.
- Three sizes are offered to fit mini cargo vans and low roof full-sized vans.
- Zinc epoxy primed for superior rust resistance.
- Chip-resistant white powder coat.
- Quick and easy to assemble and install. No drilling or cutting required.
- Driver side load retainers included.

VAN & LADDER TYPES	PART #
<b>MINI CARGO VANS</b> (Ford Transit Connect, Chevy City Express, Nissan NV200, Ram ProMaster City)	
Double Clamp & Lock Ladder Rack	40873 + 40813
Single Clamp & Lock Ladder Rack	40873
Combo Single EZ Lo-Down + Clamp & Lock Ladder Rack	40933 + 40813
<b>A   LOW ROOF FULL-SIZED VANS</b> (Chevy Express and Ford E-Series)	
Double Clamp & Lock Ladder Rack	40804 + 40813
Single Clamp & Lock Ladder Rack	40804
Combo Single EZ Lo-Down + Clamp & Lock Ladder Rack	40953 + 40813
<b>B   LOW ROOF FULL-SIZED VANS</b> (Ford Transit and Nissan NV)	
Double Clamp & Lock Ladder Rack	40903 + 40813
Single Clamp & Lock Ladder Rack	40903
Combo Single EZ Lo-Down + Clamp & Lock Ladder Rack	40923 + 40813

# CROSSBAR Cargo & Ladder Racks

## #80070 FOR MINI CARGO VANS



## #80080 FOR LOW ROOF FULL-SIZED VANS



VAN & LADDER TYPES	PART #
<b>MINI CARGO VANS</b> (Ford Transit Connect, Chevy City Express, Nissan NV200, Ram ProMaster City)	
4 Crossbar Cargo and Ladder Van Rack	80070

VAN & LADDER TYPES	PART #
<b>B   LOW ROOF FULL-SIZED VANS</b> (Ford Transit and Nissan NV. Also fits on the Low Roof Ram ProMaster and Low Roof Sprinter)	
5 Crossbar Cargo and Ladder Van Rack	80080

If you have a short van, but you may need to carry long ladders, or long materials, this Top Mount Rack is the solution that is made just for you.

- Rugged 1 5/8" dia. x .083 high tensil strength tubing.
- 500 lb. cargo capacity.
- Zinc epoxy undercoat.
- High gloss metallic silver marine grade powder coat finish.
- Swagged tube joints.
- Yellow zinc plated hardware.
- Cosmetic button heads.
- Easy to install ... no drilling required.
- Nylon self-locking nuts.
- 1,000 hour ASTM salt spray resistance.
- Convenient rear loading.

Mid-roof Transit, ProMaster and Sprinter are too high for traditional side loading Clamp & Lock or Crossbar Ladder Racks. The five bar 80080 loads from the rear. Simply lean your ladder on the protective rear crossbar that overhangs the roof. Lift the bottom of the ladder, push forward, and when you run out of arm, let er' go. The ladder front will set down on the fifth crossbar, which you will have located in the perfect spot to protect the roof of your van. Position and secure your ladder while standing on the van floor. We recommend attaching a grab strap to the bottom rung of your ladder to facilitate unloading. Durable, economical, and easy to use. Rack features 1 5/8" dia. steel tubing with metallic silver powder coat finish. 122" L x 57" W."

## CARGO & LADDER RACK ACCESSORIES

### Clamp & Lock 6' Step Ladder Bracket (Add to Carry Shorter Ladders)



40815 Add to 40803, 40804, 40903, 40873, 40813

### EZ Lo-Down 6' and 8' Step Ladder Bracket (Add for Shorter Ladders)



40816 Add to All 409xx Series Racks

### Emergency Light Mount for 409xx



40893 For All 409xx Racks

### Front Bar Wind Deflector



31570 Add to 80070, 80080, 40870, 40880

### Cargo Buckle Tie Downs



31490 See Complete Details on Inside Back Cover

### EZ Lo-Down Extender (24") to Carry Long Heavy-Duty Extension Ladders



40817 2 Bars + Mount Kit

(800) 343-7486

P30 VISIT [KARGOMASTER.COM](http://KARGOMASTER.COM) FOR MORE INFORMATION

**KARGO MASTER**  
TRUCK RACKS & CARGO VAN EQUIPMENT

# UTILITY ECONO VAN Cargo Racks

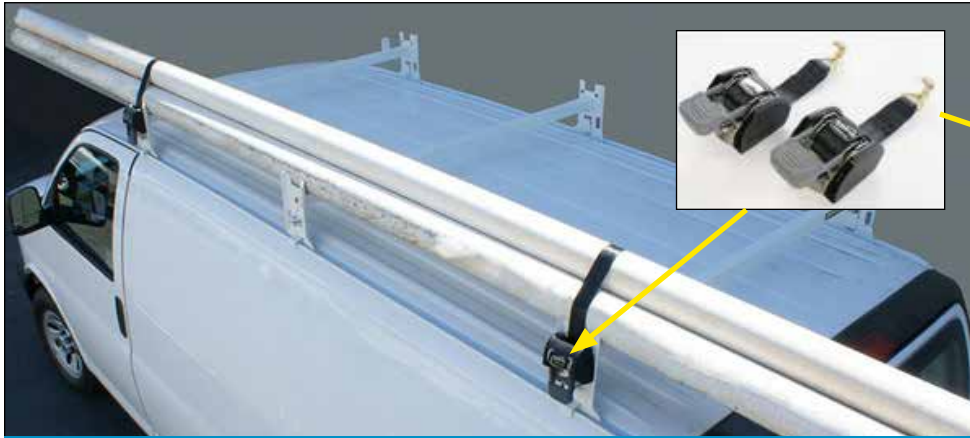

**THE KARGO MASTER UTILITY ECONO VAN CARGO RACK IS AVAILABLE WITH 2 OR 3 CROSSBARS** (See Inside Back Cover for Cargo Buckle Tie Downs Information #40850 - Shown on Racks)

## A | F/S 2 (or 3) CROSSBAR UTILITY ECONO VAN RACK

The **Kargo Master** all-purpose **Utility Econo Van Rack** is designed to be stronger than other ordinary van racks in the market. The Utility Van Rack is constructed using heavy duty 1.75" square tubes, and it is available in 2 or 3 steel cross bars. Strong wide mounting feet clamps secure the rack to rain gutter to provide maximum support, stability and offer easy, no-drill installation for your van. Feet clamps are coated to protect rain gutter paint. Ladder stops are included in the van rack package and they provide great convenience when securing your loads. All **Kargo Master** Van Racks are coated with zinc primer and thick marine grade powder coat to provide excellent corrosion resistance.

- Available with 2 or 3 heavy-duty 1.75" square steel crossbars. Wide mount feet clamp securely to rain gutter. Feet coated at bottom to protect rain gutter paint.
- Each model fits full-sized Ford E-Series, GM, older pre-Sprinter Dodge, and all full-sized vans with rain gutters.
- No drilling or cutting required.
- Zinc epoxy primed for superior rust resistance. Chip resistant WHITE ONLY powder coat.
- Ladder stop included.
- Low profile uprights enable access to low clearance parking facilities.

40823	2 Crossbar - Utility Econo Van Rack - Rain Gutter Mount - White
40824	3rd Middle Crossbar - Single - Rain Gutter Mount
40825	2 Crossbar - Utility Econo Van Rack - Rain Gutter Mount - White - (2) #40850 Cargo Buckle Tie Downs Included

## CROSSBAR LADDER RACKS FOR TRANSIT - COMING SOON

**NEW**

These steel 2 OR 3 Crossbar Racks for Transit are the most economical way to carry ladders and long rigid materials. Uprights are low profile (8" H), specially designed to accept special ratchet straps that quickly and safely secure one ladder, or a stack of ladders. Crossbars are 1.5" square steel tubing, 53" L. Uprights bolt directly to factory roof mounts. Ladder stops included. Accessory rear roller assembly available July. Roller assembly recommended for mid- roof Transit. Racks zinc primed for superior corrosion protection and powder coated white.



**FOR LOW ROOF FORD TRANSIT ONLY**

40826	Utility Van Rack TRANSIT ONLY 2 Cross Bar
40827	Utility Van Rack TRANSIT ONLY 3rd Middle Cross Bar
40828	Utility Van Rack TRANSIT ONLY 2 Cross Bar - Rain Gutter Mount - Ratchet Straps Included
40829	Rear Cross Bar Roller Assembly <b>Available July 1st</b>
40830	Ratchet Straps (add to #40826)

# HEAVY-DUTY PRO II VAN Cargo Rack



## Kargo Master Pro II Van Cargo Rack Features and Benefits

- Extends to full length of van (165" L x 55" W) for maximum cargo capacity.
- 4 heavy-duty 2" diameter crossbars to fully support long and short loads.
- Rear roller bar makes loading easy.
- Level cross bars support sheet goods, elevated standing platform, lumber, ladders, pipe, etc.
- Wide mount feet clamp securely to rain gutter.
- Feet coated at bottom to protect rain gutter paint.
- Each model fits full-sized Ford E-Series, GM Express, pre-Sprinter Dodge, and all full-sized vans with rain gutters.
- No drilling or cutting required.
- Zinc epoxy primed for superior rust resistance.
- Available in chip resistant black powder coat only.
- Quick and easy to assemble and install.
- Driver side load retainers are included.

**THIS RACK WILL FIT ANY VAN WITH RAIN GUTTERS.**

**Includes Rear Roller Bar for Easy Loading**



Rear roller bar makes it easier to load heavy ladders, bulky items, sheet goods and protects the top of the van.



## Cargo Buckle Tie Downs

- These clamp-on ratchet straps enable you to quickly and safely secure cargo on top of a rack. #31490 comes with mounting hardware.

31490 Cargo Buckle Tie Downs (Set of 2)

PART #	DESCRIPTION
40870	Pro II Heavy-Duty Material Rack Feet & Bars Kit with Real Roller
40880	Pro II Heavy-Duty Material Rack Side Channel Kit
<b>You must purchase both items to build a complete rack.</b>	

(800) 343-7486

P32 VISIT [KARGOMASTER.COM](http://KARGOMASTER.COM) FOR MORE INFORMATION

**KARGO MASTER**

TRUCK RACKS & CARGO VAN EQUIPMENT

## COVERED SERVICE BODY FIT GUIDE

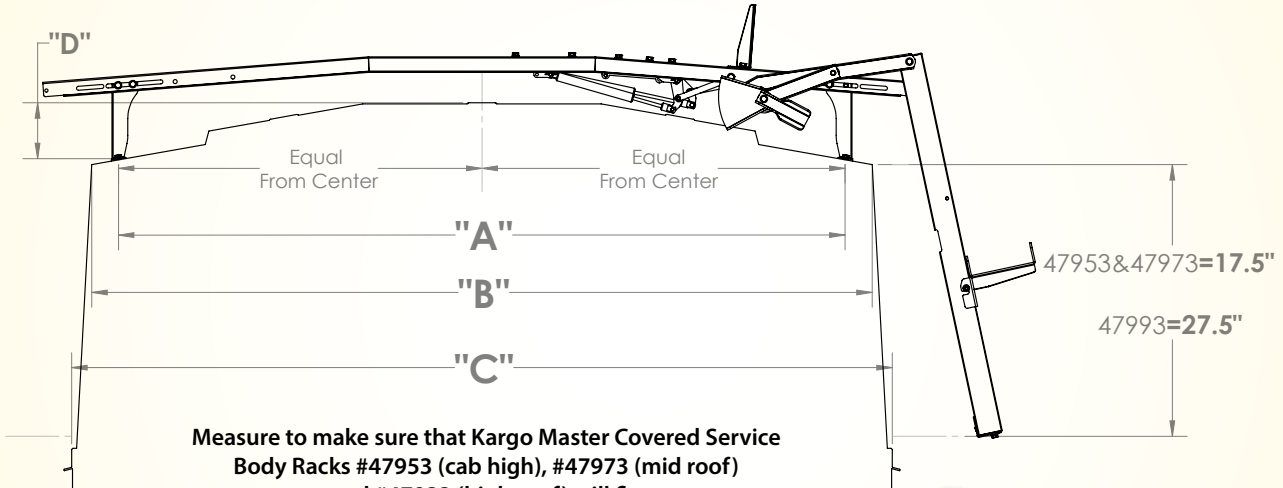

### FOUR EASY STEPS.

1. Mounting width (Dimension A) must be in the range 65" to 81.5". Locate feet (left to right) about 1" inboard from shoulder if possible.
2. Shoulder width (Dimension B) must be less than 86.5".
3. Body width at bottom of shoe (Dimension C) must be less than:
  - a. 96.5" for **Models #40953** and **#40973**. Measure this body width at a distance of 17.5" down from the shoulder (Dimension C).
  - b. 96.5" for **Model #40993**. Measure this body width at a distance of 27.5" down from the shoulder (Dimension C).
4. Crown height above foot mount location (Dimension D) must be less than 6".



### LADDER RACKS FOR COVERED SERVICE BODIES

	PART #
<b>LOW ROOF SINGLE AND DOUBLE WHEEL</b>	
Single Low Roof Covered Body EZ Lo-Down Ladder Rack	47953
Clamp & Lock Mechanism Only	40813
Drop Down Mechanism Only	40963
Double Low Roof Covered Body EZ Lo-Down Ladder Rack	47953 + 40963
Combo Low Roof Covered Body Ladder Rack	47953 + 40813
<b>MID ROOF SINGLE AND DOUBLE WHEEL</b>	
Single Mid Roof Covered Body EZ Lo-Down Ladder Rack	47973
Mid Roof Drop Down Mechanism Only	40983
Double Mid Roof Covered Body EZ Lo-Down Ladder Rack	47973 + 40983
<b>HIGH ROOF SINGLE AND DOUBLE WHEEL</b>	
Single High Roof Covered Body EZ Lo-Down Ladder Rack	47993
High Roof Drop Down Mechanism Only	40913
Double High Roof Covered Body EZ Lo-Down Ladder Rack	47993 + 40913

## The Choice is Clear: **Kargo Master** for Your **Truck Racks**.

**Kargo Master** earned its stripes by manufacturing truck racks that have simply withstood the tests of time, wear and tear, and weather conditions from mild to extreme cold and heat. **Just look at these exceptional features . . .**

### DURABILITY

**WE HATE RUST TOO!** That's why every steel component of every **Kargo Master** rack is zinc epoxy primed beneath the gloss marine grade polyester powder coat finish. This system provides over five times the corrosion protection of a conventional un-primed powder coat. All fasteners are yellow zinc plated or stainless steel. No other manufacturer goes to this expense to protect your rack and your vehicle.



### STYLE

All **Kargo Master** racks are made from round tubing that is stronger than square, and easy on the eye. Our premium full length racks have a sleek "Flying Wedge" appearance, with well proportioned top and bottom tubes. In the rear, the top tube resolves into the rear leg, forming an attractive rounded grab loop. We use clean swaged tube joints that disappear. Fasteners are smooth button head for OEM appearance. Finish is black gloss (steel) or clear coated metallic flake (aluminum).



SILVER



BLACK

### STRENGTH

Don't be misled by published rack load capacity. There is no industry standard for measuring capacity. There is a big difference between supporting a static load and supporting that load while coming to a hard stop, veering around a tight freeway off ramp, or bouncing over pot holes or railroad tracks. **Kargo Master** makes the strongest production racks available, and it is easy to understand why. We use bigger thicker round tubes, with extensive gusseting of legs and cross bars.

<b>Pro II &amp; Econo Truck</b>	<b>2" Dia. x .083" Thick High Tensile Strength Steel Mechanical Tubing</b>
<b>Pro III</b>	<b>1 5/8" Dia. x .083" Thick High Tensile Strength Steel Mechanical Tubing</b>
<b>Pro IV</b>	<b>2" Dia x .12" Think T-6 Aircraft Aluminum</b>

These premium materials provide the highest rack capacity/rack weight ratio in the industry. Think of a mountain bike frame. Know this for sure. Your **Kargo Master** rack is, and if the capable of supporting more weight than the truck it sits upon rack frame bends, cracks, breaks or mechanically fails in any way, we will replace it free, forever.

### LOAD CAPACITY AND SAFETY

We are frequently asked about how much weight our racks will carry. Rack capacity is different from the amount of weight that can be carried safely by, or without damaging the body of your vehicle. While our racks are "rated" to carry a certain load, that does not necessarily mean you can, or should carry such a load on top of your rack! The manufacturer of your truck has specified a GVW (gross vehicle weight) limitation. That specified carrying limit is designed around the stock springs, tires, body strength and other components. Additionally, you must remember that any load on top of your rack will significantly change the handling and braking characteristics of your truck and may increase the vehicle's tendency to roll over. Overloading may also damage the bodywork of your truck. Never exceed the manufacturer's cargo weight recommendations and use common sense when loading your vehicle.

(800) 343-7486

P34 VISIT [KARGOMASTER.COM](http://KARGOMASTER.COM) FOR MORE INFORMATION

**KARGO MASTER**

TRUCK RACKS & CARGO VAN EQUIPMENT

# TRUCK RACKS Application Guide

FOR TRUCKS WITHOUT SHELLS	SIDE CHANNEL		LEG & BAR
<b>PRO II HEAVY-DUTY STEEL CARGO RACK FOR FULL-SIZED TRUCKS (2" DIA.) – BLACK ONLY</b> (See page 37)			
Standard Cab - Long Bed (GM, Ram, Tundra, F-150)	04000	+	01000
Standard Cab - Long Bed (F-250, F-350)	04000	+	01040
Extended Cab/Crew Cab (GM, Ram, Tundra, F-150)	06000	+	01000
Extended Cab/Crew Cab - Short Bed 75" to 78" (GM, Ram, Tundra, F-150)	06010	+	01000
Extended Cab/Crew Cab - Long Bed (F-250 SD, F-350 SD, Ram Mega Cab)	06000	+	01040
Extended Cab/Crew Cab - Short Bed 75" to 78" (F-250 SD, F-350 SD, Ram Mega Cab)	06010	+	01040
Extended Cab/Crew Cab - Short Bed 75" (Ram Mega Box, Tundra)	06020	+	01000
<b>PRO III MEDIUM-DUTY CARGO RACK FOR FULL-SIZED &amp; MINI TRUCKS (1 5/8" DIA.) – BLACK ONLY</b> (See p 38)			
All Full-Sized (GM, Ram, Tundra, Ford)	80000		--
Mid-Sized (GM Canyon & Chevy Colorado, Tacoma*)	80020		---
*2005 & NEWER TACOMA WITH 72" BED REQUIRES ADDITIONAL PART #31270 BED RAIL			
<b>PRO IV ALUMINUM CARGO RACK FOR FULL-SIZED TRUCKS (2" DIA.) – SILVER ONLY</b> (See page 36)			
All Full-Sized (GM, Ram, Tundra, Ford, Nissan)	90000		--
<b>MEDIUM-DUTY ECONO CARGO RACKS FOR FULL-SIZED &amp; MINI TRUCKS – BLACK ONLY</b> (See page 39)			
Econo Truck Rack - 2" dia. (1 Upright - Front or Back - Clamp-On Mount)	30050		--
Quick Pack Rack - 1.5" dia. (All Full-Sized and Mini Trucks)	30090		--
FOR TRUCKS WITH SHELLS	SIDE CHANNEL		LEG & BAR
<b>PRO II HEAVY-DUTY STEEL CARGO RACK FOR FULL-SIZED TRUCKS (2" DIA.) – BLACK ONLY</b> (See page 40)			
Standard Cab - Long Bed (GM, Ram, Tundra, Ford, Nissan)	04000	+	01110
Extended Cab/Crew Cab (F-150, GM, Ram, Tundra, Nissan)	06000	+	01110
Extended Cab/Crew Cab - Short Bed 75" to 78" (GM, Ram, Tundra, F-150, Nissan)	06010	+	01110
Extended Cab/Crew Cab - Long Bed (F-250 SD, F-350 SD, Ram Mega Cab)	06000	+	01130
Extended Cab/Crew Cab - Short Bed 75" to 78" (F-250 SD, F-350 SD, Ram Mega Cab)	06010	+	01130
Extended Cab/Crew Cab - Short Bed 75" (Tundra)	06020	+	01110
<b>PRO III MEDIUM-DUTY CARGO RACK FOR MINI TRUCKS (1 5/8" DIA.) – BLACK ONLY</b> (See page 40)			
All Mid-Sized (GM, Tundra, Ford, Pre-2005 Tacoma) (Black Only)	80030		--
THIS APPLICATION WILL NOT FIT 2005 & NEWER TACOMA OR NISSAN FRONTIER			
Top Rack Mount (Silver)	80070		--
<b>MEDIUM-DUTY ECONO CARGO RACKS FOR FULL-SIZED &amp; MINI TRUCKS – BLACK ONLY</b> (See page 39)			
Econo Truck Rack - 2" dia. (Front and Back - Clamp-On Mount)	30060		--
FOR TRUCKS WITH SERVICE BODIES	SIDE CHANNEL		LEG & BAR
<b>PRO II HEAVY-DUTY STEEL CARGO RACK FOR FULL-SIZED TRUCKS (2" DIA.)</b> (See page 42)			
Standard Cab – 8 ft. Body – <b>Black</b> (Also Available in White - Part #78003 + #70023)	78000	+	70020
Extended Cab – 8 ft. Body – <b>Black</b> (Also Available in White - Part #78013 + #70023)	78010	+	70020
Standard Cab – 9 ft. Body – <b>Black Only</b>	79000	+	70020
Extended Cab – 9 ft. Body – <b>Black Only</b>	79010	+	70020
Standard Cab – 11 ft. Body – <b>Black Only</b>	79010	+	70020
Option – "A" and "B" Mounts	70060		--
8 FT. RACKS ARE AVAILABLE IN WHITE. CHANGE THE LAST DIGIT ON THE PART NUMBER FROM "0" TO "3"			
FOR TRUCKS WITH PLATFORM BODY	SIDE CHANNEL		LEG & BAR
<b>PRO II HEAVY-DUTY STEEL CARGO RACK FOR FULL-SIZED TRUCKS (2" DIA.) – BLACK ONLY</b> (See page 37)			
Standard Cab – 8 ft. Body	78000	+	70030
Standard Cab – 9 ft. Body	79000	+	70030
Standard Cab – 11 ft. Body	79010	+	70030
FOR COMMERCIAL VANS	SIDE CHANNEL		LEG & BAR
<b>PRO II HEAVY-DUTY STEEL CARGO RACK FOR COMMERCIAL VANS (2" DIA.) – BLACK ONLY</b> (See page 37)			
All Full-Sized Commercial Vans	40880	+	40870
LADDER RACKS FOR FULL-SIZED TRUCKS WITH COMMERCIAL CAPS - ALL WHITE			
Single Commercial Cap EZ Lo-Down Ladder Rack (Curb Side Only)	4093C		
Clamp & Lock Mechanism Only – Add to #4093C	40813		
Commercial Cap Drop Down Mechanism	40943		
Double Commercial Cap EZ Lo-Down Ladder Rack	4093C	+	40943
Combo Commercial Cap EZ Lo-Down + Clamp & Lock Ladder Rack	4093C	+	40813

# MEDIUM-DUTY PRO IV Aluminum Pick Up Truck Cargo Rack

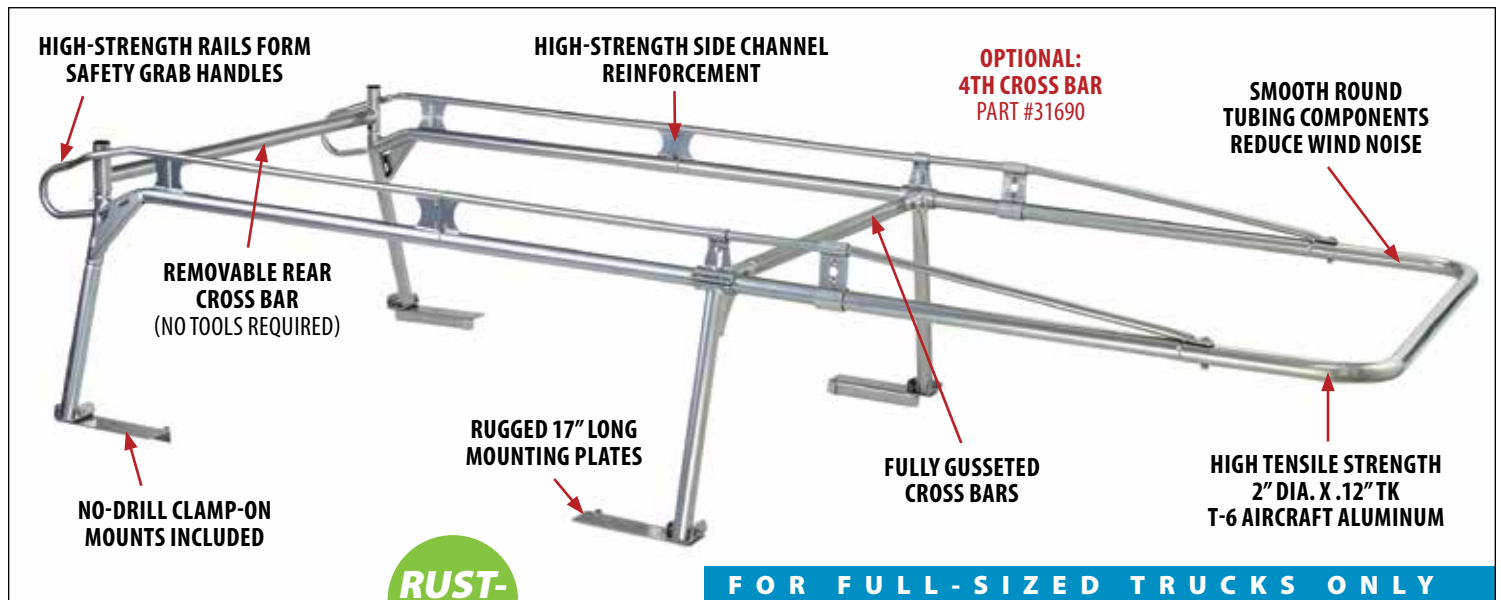

- Rugged 2" Dia. x .12" Tk. T-6 aircraft aluminum alloy tubing for superior strength.
- Attractive metallic powder coat finish with protective clear coat for sheen.
- Easy to assemble with self-locking nuts.
- 1,000# capacity.
- No-drill clamp-on mounts.
- Easily removed with 4 bolts.
- Swaged joints and fully gusseted cross bars for superior load capacity.
- All stainless steel fasteners.



**FOOT PLATE DETAIL**

## UNIQUE DESIGN

- Front legs adjust to fit any bed length.
- Mounting plates allow width adjustment to fit all full-sized trucks.

## PRO IV DIMENSIONS

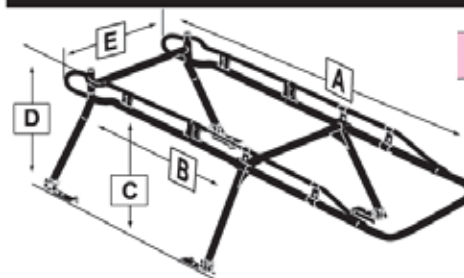

TRUCK TYPE:	Full Size
A	155"
B	56" - 98"
C	26½"
D	33"
E	54"

PRO IV ALUMINUM CARGO RACK FOR FULL-SIZED TRUCKS (2" DIA.) – SILVER ONLY	PART #		
All Full-Sized (GM, Ram, Tundra, Ford, Nissan)	90000		--
Add a 4th Cross Bar	31690		--

**(800) 343-7486**

**P36 VISIT [KARGOMASTER.COM](http://KARGOMASTER.COM) FOR MORE INFORMATION**

**KARGO MASTER**

**TRUCK RACKS & CARGO VAN EQUIPMENT**

# HEAVY-DUTY PRO II Pick Up Truck Cargo Racks

- Rack removes easily with 4 bolts.
- 5" swaged joints provide double strength.
- High-strength yellow zinc plated self-locking fasteners.
- Wide OPTIONAL: Full length bed rails available.

FREE REMOVABLE  
4TH CROSS BAR

QUICK RELEASE REAR CROSS  
BAR. NO TOOLS REQUIRED.

BUILT-IN ROPE  
TIES ON EACH LEG

NO-DRILL CLAMP-ON  
MOUNTS INCLUDED

INDUSTRY  
STRONGEST  
RACK

## THE PRO II DIFFERENCE

Serious tradesmen use substantial tools. **Kargo Master** racks are the top choice because they work hard and look great!

Here's why ...

### Bigger Tubes, Stronger Frame

- Big 2" dia. x .083" steel tube frame is the strongest available.
- 1,700" cargo capacity.
- Nationwide lifetime frame guarantee.

### Premium Powder Coat Finish

- Zinc epoxy primed for superior corrosion protection.
- Polyester marine-grade powder coat specially formulated to resist corrosion and abrasion.
- Will not fade or dull.

### Bigger Tubes, Stronger Frame

- Sleek "Flying Wedge" design.
- Smooth tubular components.
- Stylish gloss black.

FOR FULL-SIZED TRUCKS ONLY



PRO-II • TRUCK WITHOUT SHELL	TRUCK TYPE:					
	FULL SIZE Std. Cab		FULL SIZE Ext. Cab		F-250, F-350, Crew Cab	
BED TYPE:	Short	Long	Short	Long	Short	Long
A	128"	145"	155"	172"	155"	172"
B	72"	90"	72"	90"	72"	90"
C	26"				28"	
D	33"				35"	
E	53"					

## PRO II HEAVY-DUTY STEEL CARGO RACK FOR FULL-SIZED TRUCKS (2" DIA.) - BLACK ONLY

Standard Cab - Long Bed (GM, Ram, Tundra, F-150)	04000	+	01000
Standard Cab - Long Bed (F-250, F-350)	04000	+	01040
Extended Cab/Crew Cab - Long Bed (GM, Ram, Tundra, F-150)	06000	+	01000
Extended Cab/Crew Cab - Short Bed 75" to 78" (GM, Ram, Tundra, F-150)	06010	+	01000
Extended Cab/Crew Cab - Long Bed (F-250 SD, F-350 SD, Ram Mega Cab)	06000	+	01040
Extended Cab/Crew Cab - Short Bed 75" to 78" (F-250 SD, F-350 SD, Ram Mega Cab)	06010	+	01040
Extended Cab/Crew Cab - Short Bed 75" (Ram Mega Box, Tundra)	06020	+	01000

# MEDIUM-DUTY PRO III Pick Up Truck Cargo Racks



AVAILABLE FOR FULL-SIZED AND COMPACT PICKUP TRUCKS

## UNIQUE NEW DESIGN

- Front legs adjust to fit any bed length.
- Rugged .083" Tk. steel 1 5/8" tubing for superior strength.
- Abrasion and corrosion resistant "polyester marine-grade" powder paint.
- Easy to assemble with self-locking nuts.
- 1,000# capacity.
- Yellow zinc dichromate finished hardware resists corrosion up to five times longer than competitive models.
- Swaged joints and fully gusseted crossbars for superior load capacity.



## Standard Foot Plates (Four of Each Included)

- These no-drill, clamp on foot mounts and stake pocket T bolts are specially designed to allow mounting Pro II, Pro III, Pro IV or Econo Utility Trucks series racks to your truck's bed railing without drilling. Does not reduce rack's carrying capacity.



## Full-Length Accessory Bed Rails (Optional)

- These accessory bed rail-type mounts distribute the rack load, protect your pick up bed sides, and provide a strong flat base for mounting a tool box.



31300	96" Bed
31280	78" Bed
31270	72" Bed & '05 + Tacoma

PRO III DIMENSIONS		
TRUCK TYPE:	Full Size	Mini / Mid.
A	155"	142"
B	56" - 98"	48" - 84"
C	26 1/2"	23"
D	33"	29"
E	54"	48"

## PRO III MEDIUM-DUTY CARGO RACK FOR FULL-SIZED & MINI TRUCKS (1 5/8" DIA.) - BLACK ONLY

All Full-Sized (GM, Ram, Tundra, Ford)	80000		--
All Mid-Sized (GM, Ford, Pre-2005 Tacoma)	80020		---
2005 & NEWER TACOMA WITH 72" BED REQUIRES ADDITIONAL PART #31270 BED RAIL			

(800) 343-7486

P38 VISIT [KARGOMASTER.COM](http://KARGOMASTER.COM) FOR MORE INFORMATION

**KARGO MASTER**

TRUCK RACKS & CARGO VAN EQUIPMENT

# MEDIUM-DUTY ECONO Pick Up Truck Utility Racks

## QUICK PAC RACK (One Side Only – Left or Right)

- Big 1.5" x .0833" steel tube frame is the strongest available.
- 250# capacity.
- Zinc primed beneath black machine powder coat finish for superior corrosion protection.
- Adjustable arm width.
- Adjustable arm angle (horizontal or tilted).
- Fits full-sized or mini trucks.
- Uprights easily removable.



FRONT MOUNT



REAR MOUNT

### MEDIUM-DUTY ECONO CARGO RACKS FOR FULL-SIZED & MINI TRUCKS – BLACK ONLY

Quick Pac Rack - 1.5" dia. (All Full-Sized and Mini Trucks)	30090		--
---	-------	--	----

## ECONO TRUCK RACK WITHOUT SHELL



RACK PART #30050 FRONT AND BACK (PURCHASE 2 RACKS)



RACK PART #30050 CAN BE USED IN FRONT OR BACK (1 RACK)

- Big 2" dia. x .083 steel tube frame is the strongest available.
- Zinc primed beneath black marine powder coat finish for superior corrosion protection.
- Adjustable bar height – 24" or 27".
- No-drill clamp-on installation.
- Mount a double or single in front or back.
- Fits all full-sized mini trucks except step/flare side.



### MEDIUM-DUTY ECONO CARGO RACKS FOR FULL-SIZED & MINI TRUCKS – BLACK ONLY

Econo Truck Rack - 2" dia. (1 Upright - Front or Back – Clamp-On Mount)	30050		--
---	-------	--	----

# RACKS FOR PICK UP TRUCKS WITH SHELLS

## HEAVY-DUTY PRO II CARGO RACK



### Camper Shell Front Mount Assembly

With camper shell applications, the rack footplates cantilever out from the side of the truck. This unique **Kargo Master** front mount assembly eliminates stress that can bend or otherwise damage thin sheet metal used in late model truck beds. Mounting is safe, simple, and solid as a rock. Front mount assembly is included with all Camper Shell racks.

PRO-II • TRUCK WITH SHELL	TRUCK TYPE:					
	FULL SIZE				F-250, F-350, Crew Cab	
	Std. Cab		Ext. Cab		Short	Long
<b>BED TYPE:</b>	Short	Long	Short	Long	Short	Long
<b>A</b>	128"	145"	155"	172"	155"	172"
<b>B</b>	73"	91"	73"	91"	73"	91"
<b>C</b>	25" or 28" or 31"				27" or 33"	
<b>D</b>	32" or 35" or 38"				34" or 40"	
<b>E</b>	62"					

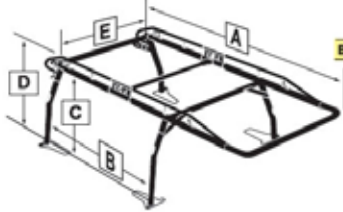

## MEDIUM-DUTY PRO III CARGO RACK



### For Mid-Sized Trucks Only

Part #80030 mounts on truck bed rail features 1 5/8" tubing, heavy-duty front mount assembly shown above, beefy .25" tk. foot plates, and a load capacity consistent with smaller mini/med trucks. Dimensions same as part #80020, except width E is 55", and heights C and D can be increased 6" with accessory leg kit part #31650.

### For All-Sized Camper Shells

Part #80070 mounts on top of camper shell. Perfect for fiberglass shells that wrap around truck bed rails. No notching for foot plates. Top mount feet can be located at any length or width between 39"-45" apart. Heavy rubber gasket between shell top and mount plate provides waterproof seal. Rack is 108" long. **NOW IN METALIC SILVER.**

## MOUNT OPTIONS FOR CAMPER SHELL RACKS

### Taller Legs for High Rise Shells

These extended camper shell legs (set of four) are longer than standard to provide extra clearance for high rise camper shells.

**Part # 31650** – 6" Taller for Mid-Sized Trucks - Pro III (#80030 only)

**Part # 31530** – 6" Taller for Full-Sized Trucks - Pro II (#01110 only)

**Part # 31540** – 6" Taller for F-250 & F-350 - Pro III (#01130 only)

FOR TRUCKS WITH SHELLS	SIDE CHANNEL		LEG & BAR
<b>PRO II HEAVY-DUTY STEEL CARGO RACK FOR FULL-SIZED TRUCKS (2" DIA.) – BLACK ONLY</b>			
<b>Standard Cab - Long Bed</b> (GM, Ram, Tundra, Ford, Nissan)	04000	+	01110
<b>Extended Cab/Crew Cab</b> (F-150, GM, Ram, Tundra, Nissan)	06000	+	01110
<b>Extended Cab/Crew Cab - Short Bed 75" to 78"</b> (GM, Ram, Tundra, F-150, Nissan)	06010	+	01110
<b>Extended Cab/Crew Cab - Long Bed</b> (F-250 SD, F-350 SD, Ram Mega Cab)	06000	+	01130
<b>Extended Cab/Crew Cab - Short Bed 75" to 78"</b> (F-250 SD, F-350 SD, Ram Mega Cab)	06010	+	01130
<b>Extended Cab/Crew Cab - Short Bed 75"</b> (Tundra)	06020	+	01110
<b>PRO III MEDIUM-DUTY CARGO RACK FOR MID-SIZED TRUCKS (1 5/8" DIA.) – BLACK ONLY</b>			
<b>All Mid-Sized</b> (GM, Ford, Pre-2005 Tacoma) (Black Only)	80030		--
THIS APPLICATION WILL NOT FIT 2005 & NEWER TACOMA OR NISSAN FRONTIER			
<b>Top Rack Mount</b> (Silver) - Also Fits Ford Transit Connect Cargo Van	80070		--

(800) 343-7486

P40 VISIT [KARGOMASTER.COM](http://KARGOMASTER.COM) FOR MORE INFORMATION

**KARGO MASTER**

TRUCK RACKS & CARGO VAN EQUIPMENT

## RACK FOR TRUCKS WITH SHELL MEDIUM-DUTY ECONO CARGO & LADDER RACK



### Fits All Trucks With Cab High Shells

Part #30060 mounts on truck bed rail, features sturdy 2" tubing, beefy .25" tk. foot plates and two height settings: 24" or 27". (High setting shown)

## RACKS FOR FULL-SIZED TRUCKS WITH COMMERCIAL CAPS



- Rugged crossbows are low over cap roof to reduce overall vehicle height and to facilitate loading and unloading.
- Easy to reach lockable clamp arm firmly secures ladder to rack.
- Curb side clamp mechanism included. Order driver side mechanism (#40813) sold separately.
- Ladder grips are adjustable to secure extension and step ladders of all sizes.
- Zinc epoxy primed for superior rust resistance. Chip resistant white powder coat.
- Quick and easy to assemble and install.
- Driver side load retainers included.

## RACKS FOR TRUCKS WITH PLATFORM BODIES

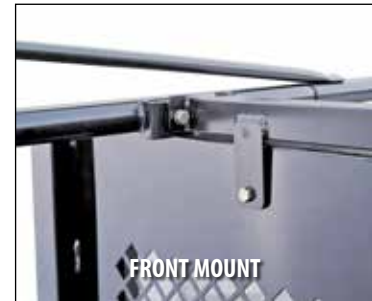

Platform racks are supported in front by the existing cab guard. The rear legs are height adjustable by cutting, with mount brackets that bolt to the platform body frame.

FOR TRUCKS WITH PLATFORM BODY	SIDE CHANNEL		LEG & BAR
<b>PRO II HEAVY-DUTY STEEL CARGO RACK FOR FULL-SIZED TRUCKS (2" DIA.) - BLACK ONLY</b> (See page 37)			
Standard Cab - 8 ft. Body	78000	+	70030
Standard Cab - 9 ft. Body	79000	+	70030
Standard Cab - 11 ft. Body	79010	+	70030
<b>LADDER RACKS FOR FULL-SIZED TRUCKS WITH COMMERCIAL CAPS - ALL WHITE</b>			
Single Commercial Cap EZ Lo-Down Ladder Rack (Curb Side Only)	4093C		
Clamp & Lock Mechanism Only - Add to #4093C	40813		
Commercial Cap EZ Lo-Down Drop Down Mechanism	40943		
Double Commercial Cap EZ Lo-Down Ladder Rack	4093C	+	40943
Combo Commercial Cap Z Lo-Down + Clamp & Lock Ladder Rack	4093C	+	40813
Top Rack Mount (Silver) - Also Fits Ford Transit Connect Cargo Van	80070		--

# SERVICE BODIES Cargo & Ladder Truck Racks



- Big 62" W crossbars provide more carrying capacity – total 1,700 lbs.
- For 8 ft. and 9 ft. service bodies – standard and extended cab.
- Service Body Racks accept all Pro II accessories. Mount clamps are available to attach your custom accessories.



## Fits Virtually All Makes and Models of Service Bodies



7" VERTICAL LEG ADJUSTMENT.  
2" FRAME LENGTH ADJUSTMENT

These highly crafted racks are quick to assemble and install. Our exclusive high strength round steel tubing and patented, precision fit interlocking components provide all the carrying capacity your truck and service body can handle. Our unique rear mounting brackets attach in areas where the rear body panel is reinforced.

Telescoping front legs ensure optimal cab clearance.

**Lifetime Frame Guarantee!**

These highly crafted racks are quick to assemble and install. Rear leg mount brackets attach to the rear panel of the body. Brackets are located at the reinforced outside corner of the box where they can be raised or lowered without hitting tail lights. The height of the rack over the cab can be optimally set for all makes and models of truck or service body. Mount brackets set the legs off 5/8" from the rear panel to accommodate top opening boxes.

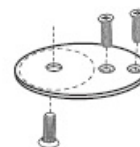
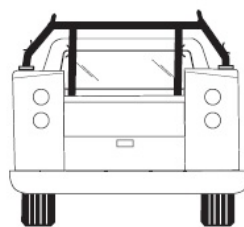

### OPTION A MOUNTS

When it is not possible to attach the included rear leg mounts to the back panel of your service body, an alternative is to mount the rear legs on top of the box. In order to do this, you must purchase our accessory mount kit #70060.

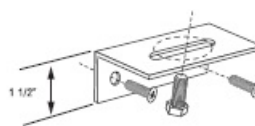

### OPTION B MOUNTS

When it is not possible to attach the included rear leg mounts to the back panel of your service body in the ATTACHING AREA as shown above, an alternative is to mount the rear legs below the box lid and above the tail light/box lock. In order to do this, you must purchase our accessory mount kit #70060.

PRO-II • SERVICE BODY	BODY TYPE:			
	8 FT.		9 FT.	9 FT. Ext. Cab
	Std. Cab	Ext. Cab	Std. Cab	11 FT. Std. Cab
A	150"	172"	160"	180"
B	27"			
C	18" - 25"			
D	25" - 32"			
E	62"			
F	48"			
G	77.5" - 79"			

FOR TRUCKS WITH SERVICE BODIES	SIDE CHANNEL		LEG & BAR
<b>PRO II HEAVY-DUTY STEEL CARGO RACK FOR FULL-SIZED TRUCKS (2" DIA.)</b> – See Page 37			
<b>Standard Cab</b> – 8 ft. Body – <b>Black</b> (*Also Available in White - Part #78003 + #70023)	78000	+	70020
<b>Extended Cab</b> – 8 ft. Body – <b>Black</b> (*Also Available in White - Part #78013 + #70023)	78010	+	70020
<b>Standard Cab</b> – 9 ft. Body – <b>Black Only</b>	79000	+	70020
<b>Extended Cab</b> – 9 ft. Body – <b>Black Only</b>	79010	+	70020
<b>Standard Cab</b> – 11 ft. Body – <b>Black Only</b>	79010	+	70020
<b>Option - A and B</b> Mounts (Specify Option "A" or "B" When Ordering)	70060		--
*8 FT. BODIES ARE AVAILABLE IN WHITE. CHANGE THE LAST DIGIT ON THE PART NUMBER FROM "0" TO "3". I.E. #78003 RATHER THAN #78000.			

(800) 343-7486

P42 VISIT [KARGOMASTER.COM](http://KARGOMASTER.COM) FOR MORE INFORMATION

**KARGO MASTER**

TRUCK RACKS & CARGO VAN EQUIPMENT

## Lockable Conduit Box Kit



Carrying stall safely secures tubing or pipe to your rack. Made of heavy gauge power coated steel. Includes complete mounting bracket kit. Use with our load dividers or when boxes are used in pairs, cargo can be locked to prevent theft.



31000 Conduit Box Kit

## Extra Cross Bar Pro II, III & IV



Provides additional support points anywhere you need them. Removes quickly for bed access or taller loads.

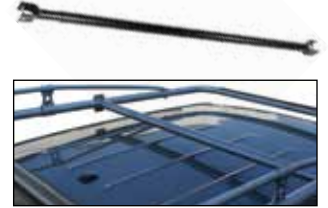

31110	2" Steel Black - Pro II
31600	1.625" Steel Black - Pro III
31690	2" Aluminum Silver - Pro IV

## Emergency Light Mount\*

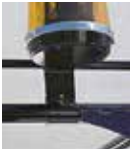

Mounts emergency flasher to any location on side rails.

31170 Emergency Light Mount Bracket

## Load Dividers\*



Clamps to cross bar tubes to control cargo movement. Use separately or with conduit box.

31020 Load Dividers (Pair)

## Window Guard for #10000, #01040 & #80000

Protects rear cab window while adding support to both the racks and the truck bed. For all Pro II racks. Powder coated 16 gauge cold rolled steel.

**Additional brackets required (#31080C) for use with #01040 Leg Kit or Pro III #80000.**



31080 Pro II Steel Full Size

## Lockable Quick Clamp Ladder Holder



31730 Lockable Quick Clamp Ladder Holder

## Mount Kit for Ram Box



31740 Mount Kit for Ram Box

## Front Bar Wind Deflector\*

All truck racks make some wind noise when air rushes around the front U bar. This clamp-on deflector can be adjusted to significantly reduce noise.



31570 Front Bar Wind Deflector

## Bed Support F/S Truck



These adjustable struts (sold in sets of two) transfer much of the rack load from the bedrail to the floor of your truck. Use in front only. For heavy loads.

31040 Bed Support Full-Sized Truck

## Cargo Buckle Tie Downs\*



These bolt-on retractable ratchet straps allow quick and easy tie down of items on top of the rack. Bushing kit included.

31490 Cargo Buckle Tie Downs (Set of 2)

## 6" Taller Leg Kit for Camper Shell Rack

These extended camper shell legs (set of four) are 6" longer than standard to provide extra clearance for high-rise camper shells.



31530	Works with #0111-0
31540	Works with #0113-0
31650	Works with #80030

## Water Jug Mount\*



Mounts Igloo™ style water barrel to leg of any Pro II pick up rack.



31160 Water Jug Mount

## Utility Hook



Side mount hook holds coiled materials within each reach of ground.

31150 Utility Hook

## Standard Full Length Bed Rails for Pro II & III

These accessory bed rail type mounts distribute the rack load, protect your pick up bed sides and provide a strong base for mounting a tool box.



31270	Pro II & III - 72" Bed
31280	Pro II & III - 78" Bed
31300	Pro II & III - 96" Bed

### Important!

Unless otherwise noted with a **red \***, all accessories listed on this page are steel and will only fit 2" dia. Pro II and IV. Parts with the **red \*** will fit Pro III, but bushing part #31700 is required.

# CARGO VAN PRODUCT Index by Part #

PT #	PG	DESCRIPTION	PT #	PG	DESCRIPTION	PT #	PG	DESCRIPTION	PT #	PG	DESCRIPTION
31570	30	Front Bar Wind Deflector	40943	28	EZ Lo-Down Mechanism Only	406SL	2	Sprinter Low Roof Wing Kit	43TRL	12	Commercial Bin Package
40010	6	42"W Shelf Door Kit	40953	28	SINGLE EZ Lo-Down Ladder Rack	406TH	2	Ford Transit MID/HIGH Roof Wing Kit	43TRM	19	Security Package
40020	6	32"W Shelf Door Kit	40963	28	EZ Lo-Down Mechanism Only	406TL	2	Ford Transit Low Roof Wing Kit	44NVL	12	General Service Package
40030	7	Shelf Dividers 3.5 Tall	40973	28	SINGLE EZ Lo-Down Ladder Rack	4070C	3	GM Side Door Hinged Window Screen	44PML	19	Cable Package
40040	6	52"W Shelf Door Kit	40983	28	EZ Lo-Down Mechanism Only	4070F	3	E-Series Side Door Hinged Window Screen	44PMS	19	Cable Package
40060	6	3-Prong "J" Hook	40993	28	SINGLE EZ Lo-Down Ladder Rack	407OT	3	2015+ Low Roof Ford Transit Side Door Hinged Window Screen	44TCL	24	Electrical Contractor Package
40070	6	Steel 2 Drawer Cabinet	47953	33	SINGLE Low Roof Covered Body EZ Lo-Down Ladder Rack	4071C	3	GM Side Door Sliding Window Screen	44TLL	17	Cable Package
40080	6	Steel 3 Drawer Cabinet	47973	33	SINGLE Mid Roof Covered Body EZ Lo-Down Ladder Rack	4071F	5	E-Series Side Door Sliding Window Screen	44TLM	19	Cable Package
40090	6	Steel 4 Drawer Cabinet	47993	33	SINGLE High Roof Covered Body EZ Lo-Down Ladder Rack	4071T	3	2015+ Low Roof Ford Transit Side Door Sliding Window Screen	44TRL	17	General Service Package
40100	8	4 Tier Refrigerant Tank Rack	48150	6	52"W Extra Shelf	4072C	5	GM Rear Door Hinged Window Screen	44TRM	19	Cable Package
40140	7	Plastic Drawer Bin with Dividers	48160	6	42"W Extra Shelf	4072F	5	E-Series Rear Door Hinged Window Screen	45NVH	20	HVAC Package
40200	8	4 Tier Refrigerant Tank Rack	48170	6	32"W Extra Shelf	4073T	5	2015+ Low Roof Ford Transit Rear Door Hinged Window Screen	45PML	20	HVAC Package
40210	8	Driver Data File	48180	6	20"L Shelf Lip	4075T	3	2015+ Low Roof Ford Transit Side Door Sliding Window Screen	45PMS	20	HVAC Package
40220	8	Cabinet Locker Full Door	48190	6	10"L Shelf Lip	4076T	5	2015+ Mid/High Roof Ford Transit Rear Door Hinged Window Screen	45SPH	20	HVAC Package
40230	8	Wire Reel Holder 5 Spindle	48200	7	20" W Plastic Bin Module	4079T	5	2014+ Ford Transit Connect Rear Door Hinged Window Screen	45SPL	20	HVAC Package
40250	10	Steel 3 Long Heavy-Duty Drawer	48210	7	10" W Plastic Bin Module	407CE	22	Commercial Shelving Package	45TCL	23	HVAC Package
40260	10	Rotating Rear Wheel Well	48220	6	42"W Floor Angle with Shelf Lip	40NVH	18	Base Package	45TLL	13	Heating & A/C Repair Package
40270	8	Hanging File Rack	48230	6	52"W Floor Angle with Shelf Lip	40NVL	11	Base Package	45TLM	20	HVAC Package
40280	8	Standing Binder Rack	48240	7	20" W Plastic Small Parts Bin Module	40PML	18	Base Package	45TRL	14	Electric & Gas Appliance Repair Package
40290	8	Standing Bin Holder	48250	7	10" W Plastic Small Parts Bin Module	40PMS	18	Base Package	45TRM	20	HVAC Package
40300	8	Wire Water Jug Holder	48320	5	Adjustable Shelf 32"W x 46" H	40SPH	18	Base Package	46NVH	21	EZ All Trades Package
40310	7	Plastic Shelf Bin 10"W	48420	5	Adjustable Shelf 42"W x 46" H	40SPL	18	Base Package	46NVL	13	Heating & A/C Repair Package
40330	7	Plastic Small Parts Shelf Bin 5"W	48424	5	Adjustable Shelf 42"W x 60" H	40TCL	22	Commercial Shelving Package	46PML	21	EZ All Trades Package
40620	8	Center Panel Latch and Door Lock Kit	48520	5	Adjustable Shelf 52"W x 46" H	40TCS	22	Commercial Shelving Package	46PMS	21	EZ All Trades Package
40640	2	Common LOW Roof Partition Panels	48524	5	Adjustable Shelf 52"W x 60" H	40TLL	11	Base Package	46SPH	21	EZ All Trades Package
40651	2	Common MID/HIGH Roof Partition	80070	30	1 5/8" Dia. 4 Crossbar Ladder Rack	40TRL	18	Base Package	46SPL	21	EZ All Trades Package
40667	2	All Transit Connect/City Express/NV200 Partitions	80080	30	1 5/8" Dia. 5 Crossbar Ladder Rack	40TRM	18	Base Package	46TCL	25	Telecom Package
40668	2	New Transit Connect/City Express/NV200 Wire Partition	4001C	11	Base Package	41NVH	18	General Service Package	46TLL	15	EZ All Trades Package
40804	29	SINGLE Clamp & Lock Ladder Rack	4002C	16	General Contractor Package	41PML	18	General Service Package	46TLM	21	EZ All Trades Package
40813	29	Clamp & Lock Mechanism Only	4003C	12	Commercial Bin Package	41PMS	18	General Service Package	46TRL	13	Heating & A/C Repair Package
40815	30	Clamp & Lock 6 ft. Step Ladder Bracket	4004C	12	General Service Package	41SPH	18	General Service Package	46TRM	21	EZ All Trades Package
40816	30	EZ Lo-Down 6 ft. and 8 ft. Step Ladder Bracket	4005C	14	Electric & Gas Appliance Repair	41SPL	18	General Service Package	4700C	9	GM Cab Steps, Driver & Passenger Side
40817	30	EZ Lo-Down Rack Extender to Carry Long Heavy Extension Ladders	4006C	13	Heating & A/C Repair Package	41TCL	23	Deluxe Commercial Shelving Package	4700F	9	E-Series Ford Cab Steps, Driver & Passenger Side
40823	31	Utility Van Rack 2 Crossbar - Rain Gutter Mount	4007C	15	EZ General Service Package	41TCS	24	General Service Package	4700T	9	Transit Cab Steps, Driver & Passenger Side
40824	31	Utility Van Rack 3rd Crossbar - Rain Gutter Mount	400CE	22	Commercial Shelving Package	41TLL	12	General Service Package	4701C	9	GM Passenger
40825	31	Utility Van Rack 2 Crossbar - Rain Gutter Mount with Ratchet Straps	400PC	22	Commercial Shelving Package	41TLM	18	Base Package	4701F	9	E-Series Ford Passenger Area Step
40826	31	Utility Van Rack 2 Crossbar	4010C	13	Tradesman Service Package	41TRL	13	Tradesman Service Package	4701T	9	Transit Passenger Area Step
40827	31	Utility Van Rack 3rd Middle Crossbar	4011C	16	America's Most Popular Package	41TRM	18	General Service Package	4702T	9	Transit Long Wheel Base Passenger Area Step
40828	31	Utility Van Rack 2 Crossbar - Rain Gutter Mount - Ratchet Straps Included	4012C	15	EZ All Trades Package	42PML	20	Electrical Contractor Package	47PML	21	America's Most Popular Package
40829	31	Rear Crossbar Roller Assembly	4013C	11	Partition, Racks and Bins Package	42PMS	20	Electrical Contractor Package	47PMS	21	America's Most Popular Package
40830	31	Ratchet Straps	401CE	23	Deluxe Commercial Shelving	42TCL	24	General Service Package	47TCL	22	Commercial Shelving Package
40850	IBC	Cargo Buckle Tie Downs (Pair)	401PC	23	Deluxe Commercial Shelving	42TLL	14	Electrical Contractor Package	47TCS	22	Commercial Shelving Package
40870	32	Pro II Heavy-Duty Material Rack Feet & Bars Kit with Real Roller	402CE	24	General Service Package	42TLM	20	Electrical Contractor Package	47TLL	16	America's Most Popular Package
40873	29	SINGLE Clamp & Lock Ladder Rack	402PC	24	General Service Package	42TRL	16	General Contractor Package	47TLM	21	America's Most Popular Package
40880	32	Pro II Heavy-Duty Material Rack Side Channel Kit	403CE	25	Plumbing Package	42TRM	20	Electrical Contractor Package	47TRL	15	EZ General Service Package
40893	30	Emergency Light Mount For 409xx	403PC	25	Plumbing Package	43PML	19	Security Package	4826T	5	Adjustable Shelf 26"W x 46" H
40903	29	SINGLE Clamp & Lock Ladder Rack	404CE	24	Electrical Contractor Package	43PMS	19	Security Package	4832M	5	Adjustable Shelf 32"W x 46" H
40913	28	High Lo-Down Mechanism Only	404PC	24	Electrical Contractor Package	43TCL	25	Plumbing Package	48TLL	15	EZ General Service Package
40923	28	SINGLE EZ Lo-Down Ladder Rack	405CE	23	HVAC Package	43TLL	17	Security Package	48TRL	16	America's Most Popular Package
40933	28	SINGLE EZ Lo-Down Ladder Rack	405PC	23	HVAC Package	43TLM	19	Security Package	49NVL	15	EZ All Trades Package
			4061S	2	Sprinter HIGH Roof Partition				49TRL	15	EZ All Trades Package
			4064C	2	GM Wing Kit						
			4064F	2	Ford E-Series Wing Kit						
			4064P	2	Ram ProMaster Low AND High Roof Wing Kit						
			406CE	25	Telecom Package						
			406NH	2	Nissan NV High Roof Wing Kit						
			406NL	2	Nissan NV Low Roof Wing Kit						
			406PC	2	Ram ProMaster City Partiton						
			407PC	25	Telecom Package						

\* Ford E-Series packages are not featured in catalog. For information on these products, please visit [kargomaster.com](http://kargomaster.com).

(800) 343-7486

P44 VISIT [KARGOMASTER.COM](http://KARGOMASTER.COM) FOR MORE INFORMATION

**KARGO MASTER**

TRUCK RACKS & CARGO VAN EQUIPMENT

PT #	PG	DESCRIPTION	PT #	PG	DESCRIPTION	PT #	PG	DESCRIPTION
<b>Pro II Heavy-Duty Racks for Full-Sized Trucks</b>			31280	43	Standard Full Length Bed Rails - 78"	70060	42	Top of Box Mount Kit
01000	37	Legs & Bars (Trucks w/o Shell)	31300	43	Standard Full Length Bed Rails - 96"	70070		Service Body Window Guard
01040	37	Legs & Bars (Trucks w/o Shell)	31490	43	Cargo Buckle Tie Downs	70073		Service Body Window Guard
01110	40	Legs & Bars (Trucks w/Shell)	31530	40	6" Taller Legs for 0111-0	78000	42	Side Channels - Standard Cab - 8 ft. Body - Black
01130	40	Legs & Bars (Trucks w/Shell)		43		78003	42	Side Channels - Standard Cab - 8 ft. Body - White
04000	37	Side Channels for Full-Sized Standard Cab - 96" Bed	31540	40	6" Taller Legs for 0113-0	78010	42	Side Channels - Extended Cab - 8 ft. Body - Black
	40			43		78013	41	Side Channels - Extended Cab - 8 ft. Body - White
06000	37	Side Channels for Full-Sized Extended Cab - 96" Bed	31570	43	Front Bar Wind Deflector		42	8 ft. Body - White
	40		31600	43	Extra Crossbar	79000	41	Side Channels - Standard Cab - 9 ft. Body - Black
06010	37	Side Channels for Full-Sized Extended Cab - 78" Bed	31650	40	6" Taller Legs for 80030		42	
	40			43		79010	41	Side Channels - Extended Cab - 9 ft. Body & Extended Cab - 11 ft. Body
06020	37	Side Channels for Full-Sized Extended Cab - 75" Bed	31690	43	Extra Crossbar for Pro IV	<b>Pro III Medium-Duty Racks for Mid-Sized &amp; Full-Sized Trucks</b>		
	40		31730	43	Lockable Quick Clamp Ladder Holder	80000	38	Rack for Full-Sized Trucks w/o Shell
<b>Medium-Duty Utility Racks</b>			31740	43	Mount Kit for Ram Box	80020	38	Rack for Mid-Sized Trucks w/Shell
30050	39	Rack (1 Upright - Front or Back) - W/O Shell	<b>Ladder Racks for Trucks with Commercial Caps</b>			80030	40	Rack for Mid-Sized Trucks w/Shell
30060	41	Rack (Front & Back) Trucks w/Shell	4093C	41	SINGLE Commercial Cap EZ Lo-Down Ladder Rack	80070	40	Top Mount Rack for Trucks w/Shells
30090	39	Quick Pac Utility Rack	40813	41	Clamp & Lock Mechanism Only		41	
<b>Accessories</b>			40943	41	Commercial Cap EZ Lo-Down Drop Down Mechanism	<b>Pro IV Medium-Duty Aluminum Racks for Full-Sized Trucks</b>		
31000	43	Lockable Conduit Box	80070	40	Top Mount Rack for Trucks w/Shells	90000	36	Aluminum Truck Rack
31020	43	Load Dividers		41		31690	36	Extra Crossbar
31040	43	Bed Support Full-Sized Truck	<b>Pro II Heavy-Duty Racks for Service &amp; Platform Bodies</b>				43	
31080	43	Window Guard	70020	42	Service Body Legs & Bars			
31080C	43	Clamps to Attach Window Guard	70023	42	Service Body Legs & Bars			
31110	43	Extra Crossbar	70030	41	Platform Body Legs & Bars			
31150	43	Utility Hook						
31160	43	Cooler Mount						
31170	43	Emergency Light Mount Bracket						
31270	43	Standard Full Length Bed Rails - 72"						

## TIE YOUR RACKS, OR CARGO, DOWN EASILY AND SECURELY



### Kargo Master Cargo Buckle Tie Downs & Ratchet Straps

#### THE WORLD'S BEST CARGO RETENTION SYSTEM

Utility Van Rack uprights are specially made to mount retractable strap mechanism.

- Securing ladders, sheet goods or building materials has never been easier.
  1. Release the retractable ratchet strap
  2. Wrap around your cargo and hook into the rack upright.
  3. Flick the ratchet lever and BAM, everything is locked down.
- No more fumbling with loose bungee cords or straps.
- You will save enough time to pay this Rack + Ratchet Strap system off in a month.



31490 Cargo Buckle Tie Downs **FOR TRUCKS** (set of 2)

40850	Cargo Buckle Tie Downs <b>FOR VANS</b> (set of 2)
40830	1" Ratchet Straps <b>FOR NEW TRANSIT RACK</b> (set of 2) See page 31 for photo and crossbar rack.

**#40850 CARGO BUCKLE TIE DOWNS ARE INCLUDED WITH #40825 OR CAN BE PURCHASED FOR OTHER VEHICLES.**



## Industry Best Warranty

### LIFETIME STRUCTURAL WARRANTY

If your product cracks, bends, or structurally fails in any way, Kargo Master, at its option and expense, will either replace or repair the product.

### 3 YEAR COMPONENT WARRANTY

If any synthetic (e.g. rubber or nylon) or hydraulic (e.g. gas shock) component of your product fails within 3 years of purchase, Kargo Master will provide a replacement component at no cost to you.

# KARGO MASTER®

11261 Trade Center Dr., Rancho Cordova, CA 95742

(800) 343-7486 Fax: (916) 638-0177

info@kargomaster.com kargomaster.com

DISTRIBUTED BY:

